

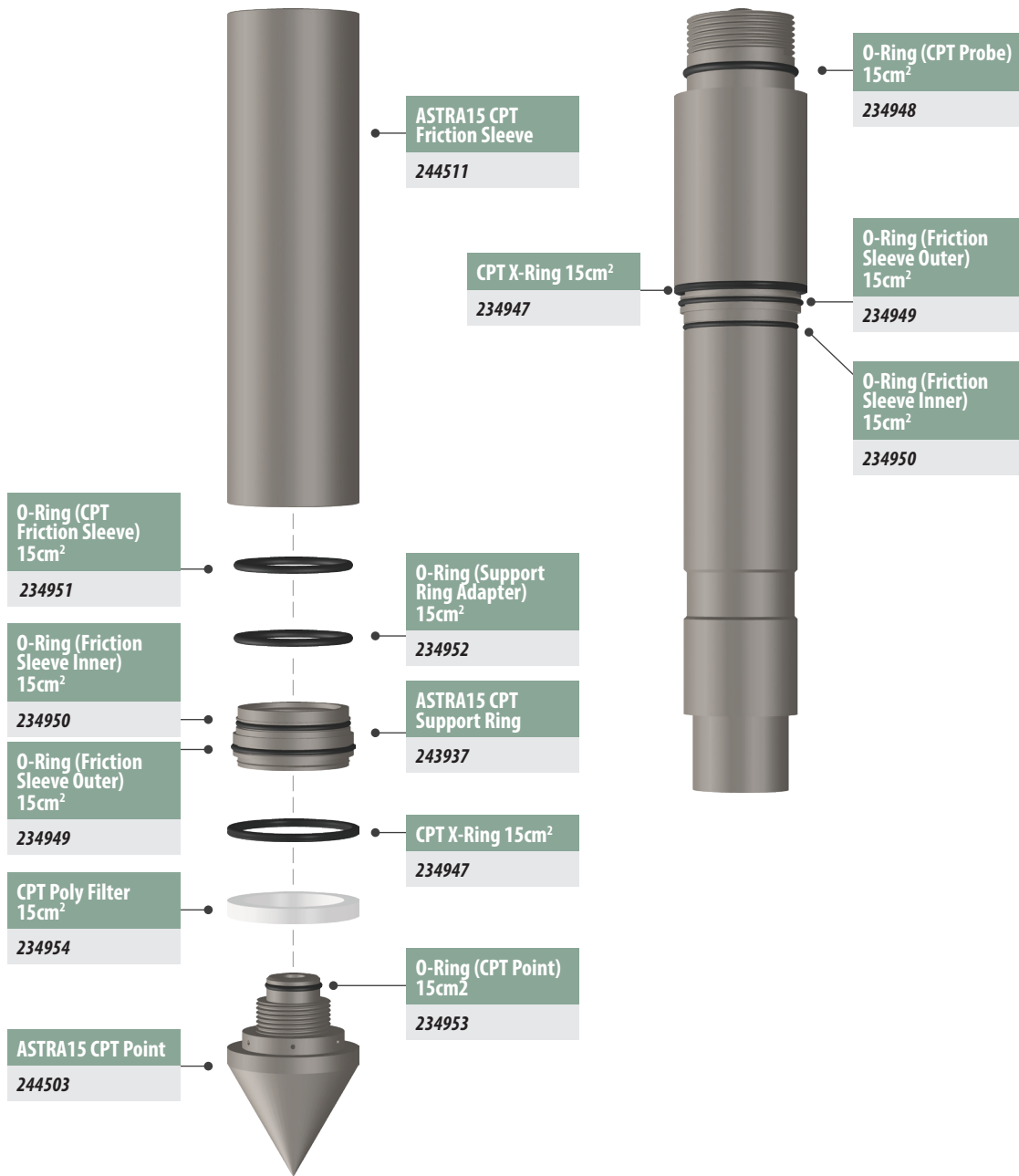





Accessories





Components	Part	MN	Notes
	ASTRA CPT Point 10cm <sup>2</sup>	239574	O-ring: 600502
	ASTRA CPT Friction Sleeve 150cm <sup>2</sup>	239199	
	ASTRA Support Ring	238896	
	CPT Poly Filter Ring 10cm <sup>2</sup>	233770	Quantity: 10
	CPT X-Ring 10cm <sup>2</sup>	600128	
	O-Ring (Friction Sleeve) 10cm <sup>2</sup>	600505	Quantity: 10

Components	Part	MN	Notes
	O-Ring (Support Ring Inner) 10cm <sup>2</sup>	600504	Quantity: 10
	O-Ring (CPT Point) 10cm <sup>2</sup>	600502	
	O-Ring (CPT Probe) 10cm <sup>2</sup>	600503	
	CPT Filter Ring	600125	Brass
	NOVA CPT Battery Plug	600539	



#### Accessories

Components	Part	MN	Notes
	ASTRA15 CPT Friction Sleeve	244511	
	ASTRA15 CPT Point	244503	
	ASTRA15 CPT Support Ring	243937	
	CPT X-Ring 15cm <sup>2</sup>	234947	Quantity: 10
	CPT Poly Filter 15cm <sup>2</sup>	234954	Quantity: 10
	O-Ring (CPT Probe) 15cm <sup>2</sup>	234948	Quantity: 10

Components	Part	MN	Notes
	O-Ring (Friction Sleeve Outer) 15cm <sup>2</sup>	234949	Quantity: 10
	O-Ring (Friction Sleeve Inner) 15cm <sup>2</sup>	234950	Quantity: 10
	O-Ring (CPT Friction Sleeve) 15cm <sup>2</sup>	234951	Quantity: 10
	O-Ring (Support Ring Adapter) 15cm <sup>2</sup>	234952	Quantity: 10
	O-Ring (CPT Point) 15cm <sup>2</sup>	234953	Quantity: 10

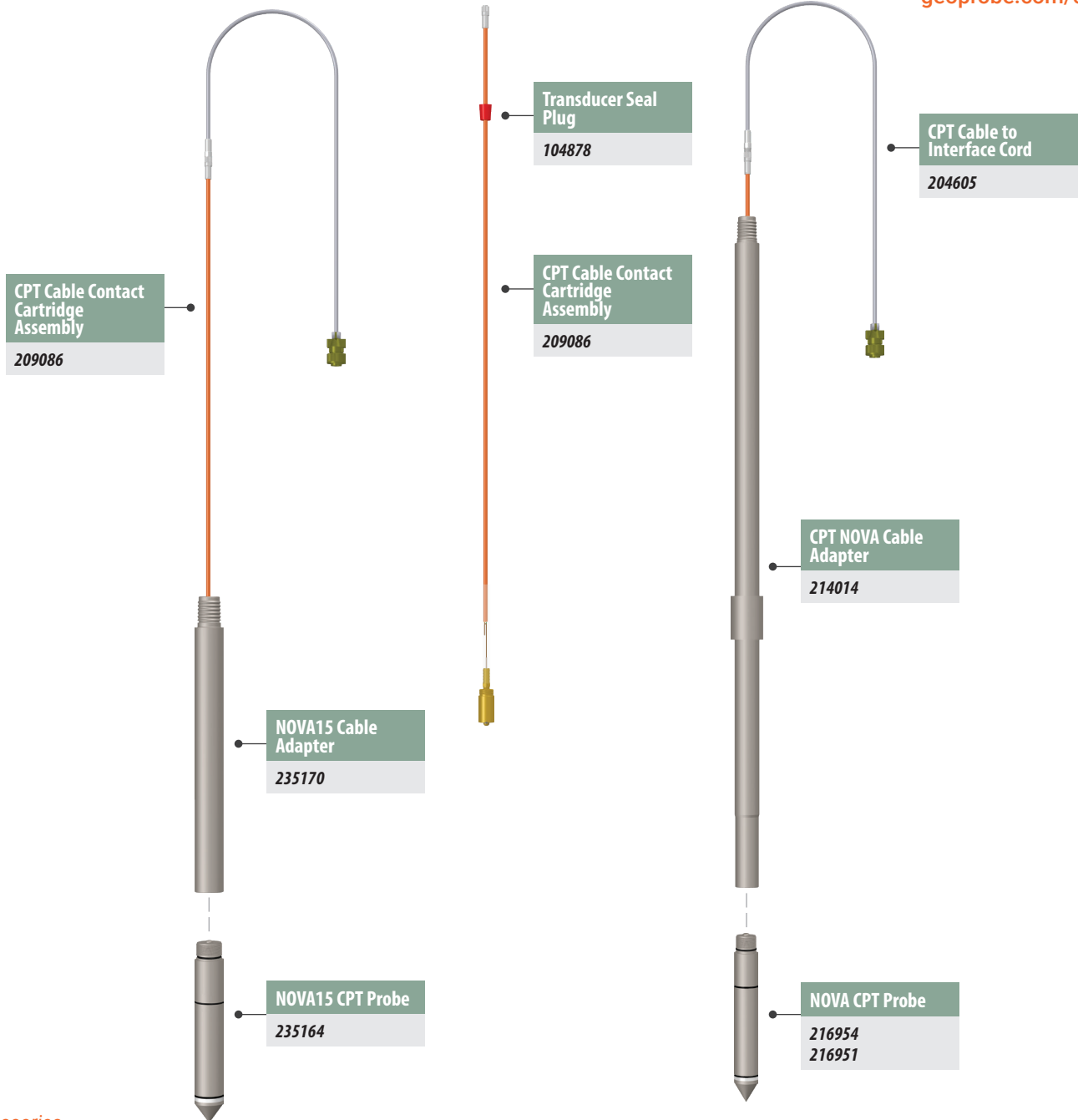

Accessories

Components	Part	MN	Notes
	<b>NOVA15 CPT Probe</b>	235164	100, 1.5, 5.0, Tilt
	<b>NOVA CPT Cable Probe</b>	216954	100, 1.0, 2.0, Tilt
	<b>NOVA CPT Probe</b>	216951	100, 1.0, 5.0, Tilt (Custom)
	<b>CPT NOVA Cable Adapter</b>	214014	1.5 in. Rod Assembly
	<b>NOVA15 Cable Adapter</b>	235170	
	<b>NOVA15 CPT Cable Probe</b>	234930	100, 1.5, 5.0, Tilt

Components	Part	MN	Notes
	<b>CPT Cable Contact Cartridge Assembly</b>	209086	
	<b>Soil Conductivity Probe Cord</b>	214229	97 ft.
	<b>CPT Cable to Interface Cord</b>	204605	1 ft.
	<b>Transducer Seal Plug</b>	104878	
	<b>1.75 in. Drive Head</b>	220545	1.75 Box x 1.5 Pin

[geoprobe.com/cpt](http://geoprobe.com/cpt)

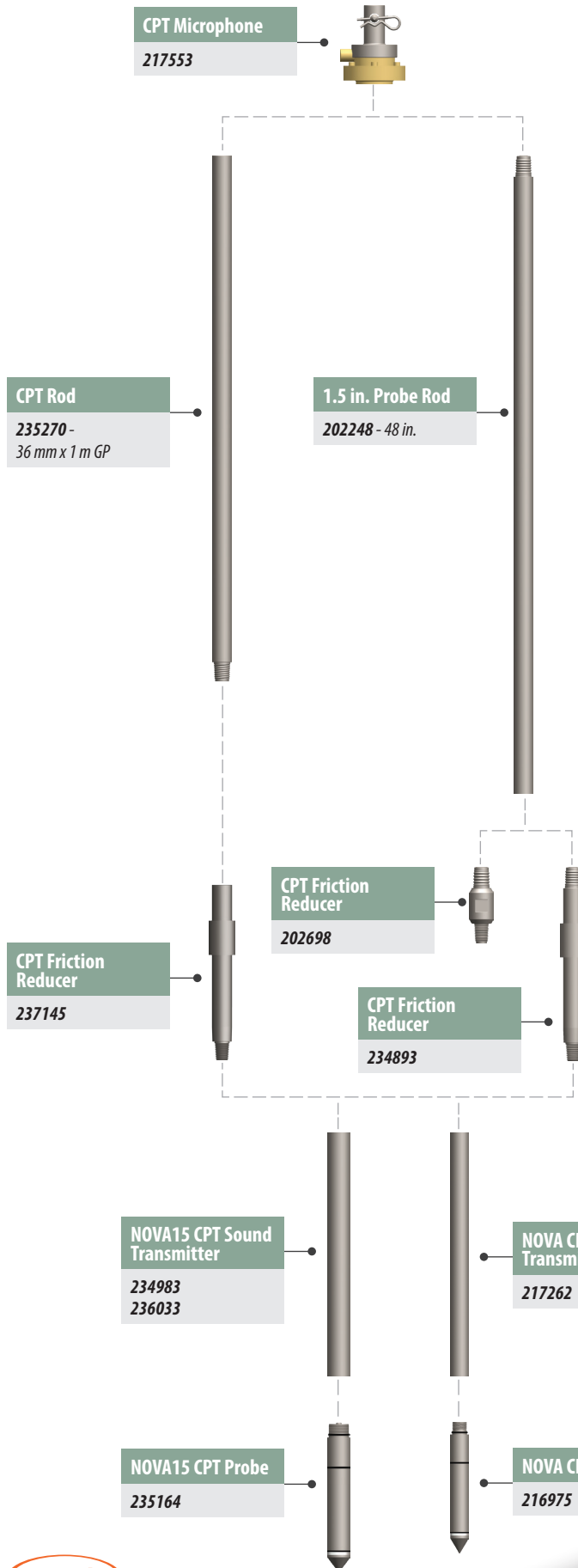

### Accessories

Components	Part	MN	Notes
	CPT Microphone	217553	20 ton
	CPT Rod	235270	36 mm x 1 m GP, rope thread
	1.5 in. Probe Rod	202248	48 in.
	CPT Friction Reducer	237145	CPT/GP Box, 2 in. OD
	CPT Friction Reducer	202698	1.5/CPT
	NOVA15 CPT Sound Transmitter	234983	
	CPT Friction Reducer	234893	1.5/CPT, 12 in.
	NOVA15 Sound Transmitter	236033	44 mm Rod
	NOVA CPT Sound Transmitter	217262	
	NOVA15 CPT Probe	235164	100, 1.5, 5.0, Tilt
	NOVA CPT Probe	216975	Q=100 FS=1.0 U=2
	CPT Microphone Mount	202107	54 Series
	CPT Microphone Mount Top Bolt	201278	
	CPT Microphone Mount	203972	1-5/8 in. Hex
	CPT Microphone Mount	202548	GH60 Series
	NOVA CPT Mic Cable	206640	Cordless CPT 10cm <sup>2</sup>

### Geoprobe® CPT Platforms

[geoprobe.com/cpt-platforms](http://geoprobe.com/cpt-platforms)

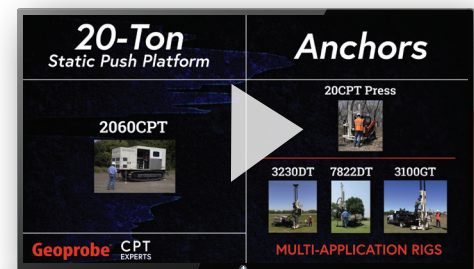

This video takes a look at the various CPT platforms Geoprobe® has available.

Seismic Sections

Components	Part	MN	Notes
	GP10 Seismic Section	236237	
	GP10 Seismic Section, GP CPT Box	239429	
	GP15 Seismic Section V2	238116	
	GP15 Seismic Section V2, GP CPT Box	240664	

Replaceable Trigger Components

Components	Part	MN	Notes
	SCPT PIEZO Trigger Switch Set	250011	
	Seismic CPT Hammer with Trigger	202781	
	Seismic Shear Plate	205448	
	Seismic CPT Shear Plate Cable	236645	
	Seismic CPT Hammer	236641	
	Seismic CPT Hammer Cable	236614	
	Seismic CPT Trigger Connection Hub	236643	
	Seismic CPT Trigger Cable	236528	15 ft.
	Seismic CPT Trigger Hub Connection Cable	236648	

Replaceable Interface Cables

Components	Part	MN	Notes
	DI Cordset 5 Cond	236232	0.25 in. X 150 ft.
	Cable, 2m, USB "A" to Sealed USB "B"	500965	
	GP Seismic Trunkline Adapter Cable	236525	3 ft.
	Seismic CPT to CPT Cable	235456	4 ft.
	Seismic CPT Trigger Cable	236528	15 ft.

Probes

Components	Part	MN	Notes
	ASTRA15 CPT Probe	244630	100, 2.0, 5, Tilt
	ASTRA CPT Probe	243677	100, 1.0, 2.0, Tilt
	ASTRA CPT Probe	246425	100, 1.0, 5.0, Tilt

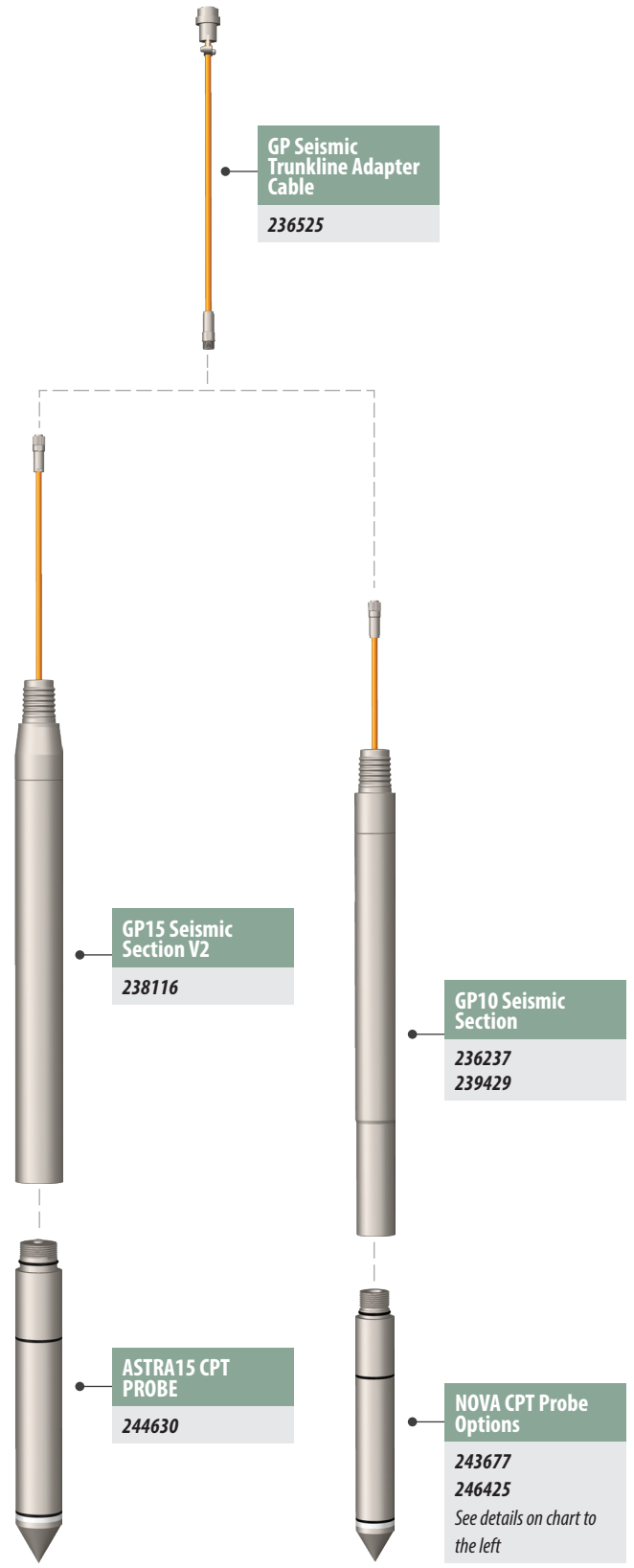

[geoprobe.com/cpt](http://geoprobe.com/cpt)

### Interface & Cables

Components	Part	MN	Notes
	ASTRA Computer Interface w/ Software	243721	
	NOVA CPT Computer Interface	217259	
	USB to Serial Converter	103782	
	NOVA CPT Stringpot	235932	
	CPT Serial Cable	232928	3 ft.
	CPT Serial Cable	201292	20 ft.
	CPT Serial Cable	203435	35 ft.
	CPT Power Cable	234108	12V, 3 ft.
	CPT - Machine Power Cable	237095	12V, 9 ft.
	CPT Power Cable	202547	12V Plug
	NOVA CPT Mic Cable	232929	9 ft.
	NOVA CPT Mic Cable	206640	
	CPT Microphone Cable	201291	20 ft.
	NOVA CPT Stringpot Cable	232927	9 ft.
	NOVA CPT Stringpot Cable	216972	17 ft.
	NOVA CPT Stringpot Cable	209709	32 ft.

### Anchors & Accessories

Components	Part	MN	Notes
	Soil Anchor	235227	10 in. Spiral, 1.625 Hex
	Soil Anchor	235239	15 in. Spiral, 1.625 Hex
	Soil Anchor Extension	205072	60 in.
	Soil Anchor Extension	235575	12 in. Spiral, Used for dual anchor
	Hex Extension	234097	12 in.
	CPT Anchor Bridge	239335	4 ft.
	CPT Anchor Footbridge	212131	Larger foot bridge
	CPT Bridge Weldment	231180	78/31 Series
	Soil Anchor Pinning Brackets	205209	Holds anchors against bridge

### Accessories

Components	Part	MN	Notes
	HSA Auger Connecting Pin	600193	1-5/8 in. Hex, 77/66 Series Machines
	Rod Bushing CPT/1.5	205617	6625CPT
	CPT Rod Guide	231522	78/31 Series
	GP CPT Transport Case	219940	
	CPT - PRO Interpretation Software	600167	
	CPT Saturation Kit	205233	
	NOVA Memory Download USB Cable	206689	
	15cm² CPT No-Go Gauge	236688	
	10cm² CPT No-Go Gauge	236689	

### Friction Reducers and Adapters



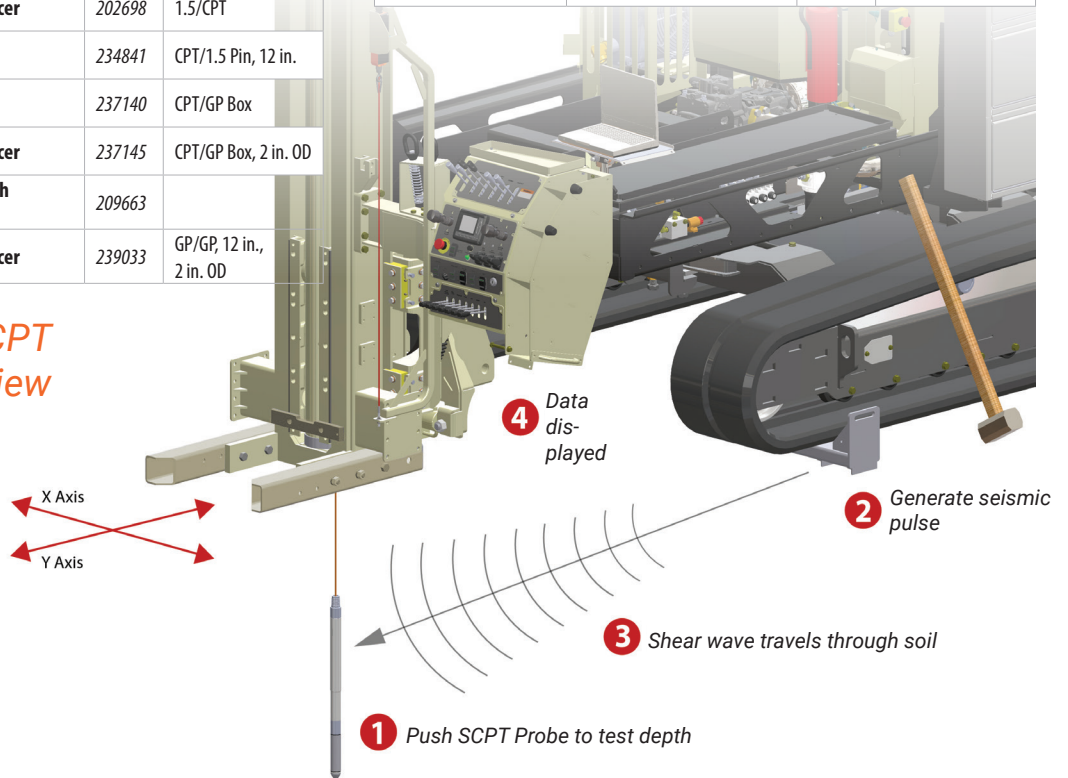

Components	Part	MN	Notes
	CPT Friction Reducer	236659	1.5/1.5, 12 in.
	CPT Friction Reducer	234893	1.5/CPT, 12 in.
	CPT Friction Reducer	202698	1.5/CPT
	CPT Adapter	234841	CPT/1.5 Pin, 12 in.
	CPT Adapter	237140	CPT/GP Box
	CPT Friction Reducer	237145	CPT/GP Box, 2 in. OD
	NOVA CPT Rod with Friction Reducer	209663	
	CPT Friction Reducer	239033	GP/GP, 12 in., 2 in. OD

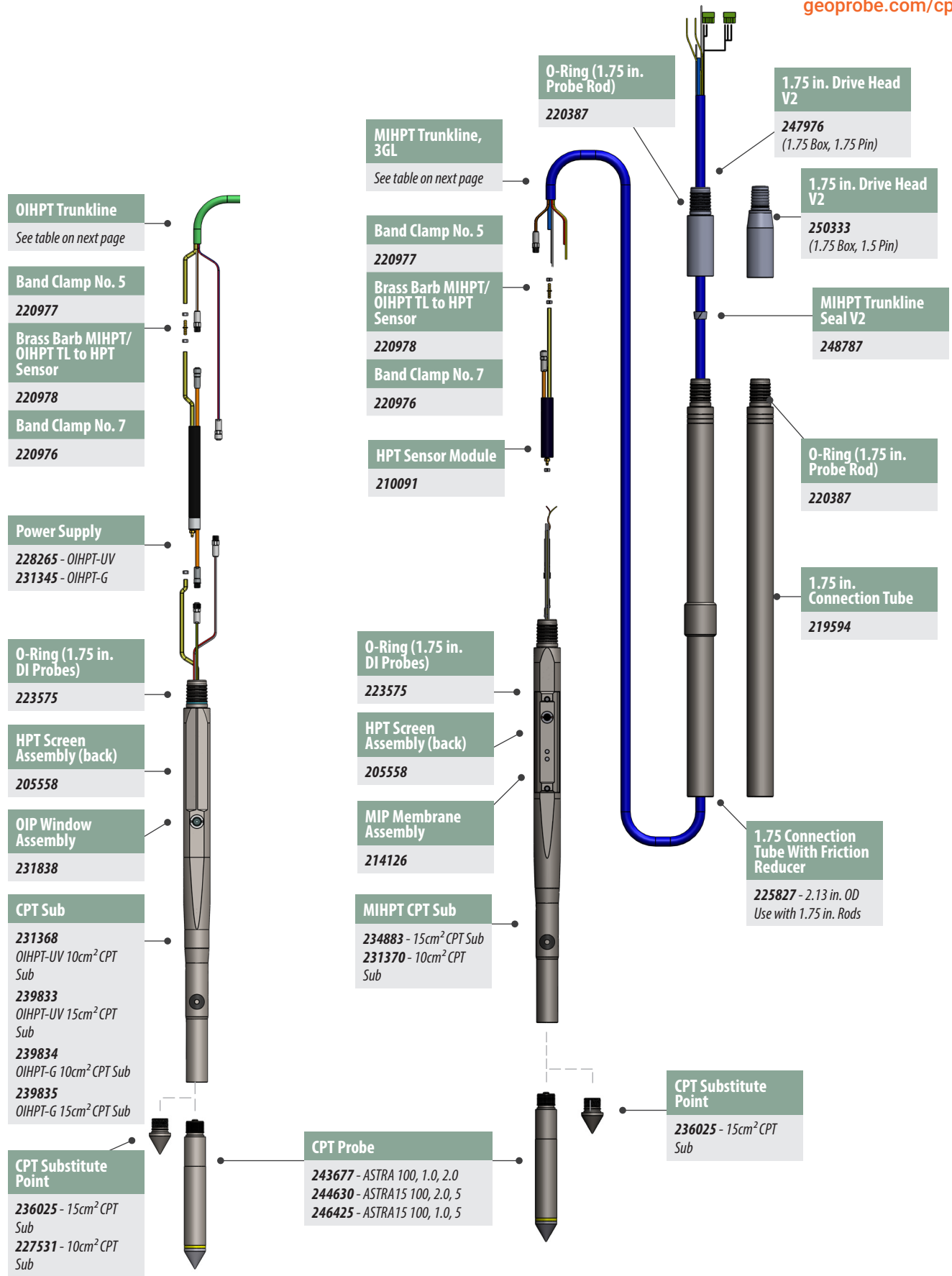
## Seismic CPT Overview





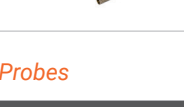
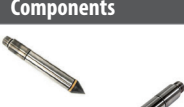



Subs

Components	Part	MN	Notes
	<b>OIHPT-UV 10cm² CPT Sub</b>	231368	For 10cm² Cone
	<b>OIHPT-UV 15cm² CPT Sub</b>	239833	For 15cm² Cone
	<b>OIHPT-G 10cm² CPT Sub</b>	239834	For 10cm² Cone
	<b>OIHPT-G 15cm² CPT Sub</b>	239835	For 15cm² Cone
	<b>MIHPT 15cm² CPT Sub</b>	234883	For 15cm² Cone
	<b>MIHPT 10cm² CPT Sub</b>	231370	For 10cm² Cone

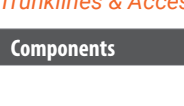
Probes

Components	Part	MN	Notes
	<b>ASTRA CPT Probe</b>	243677	100, 1.0, 2.0, Tilt
	<b>ASTRA CPT Probe</b>	246425	100, 1.0, 5.0, Tilt
	<b>ASTRA15 CPT Probe</b>	244630	100, 2.0, 5.0, Tilt

Trunklines & Accessories

Components	Part	MN	Notes
	<b>OIHPT Trunkline</b>	228253	100 ft.
		228254	150 ft.
		231482	200 ft.
	<b>MIHPT Trunkline, 3GL</b>	236309	100 ft.
		236310	150 ft.
		236311	200 ft.

Accessories

Components	Part	MN	Notes
	<b>CPT Substitute Point 10cm²</b>	227531	
	<b>CPT Substitute Point 15cm²</b>	236025	
	<b>OIP Window Assembly</b>	231838	4 mm
	<b>MIP Membrane Assembly</b>	214126	
	<b>HPT Screen Assembly</b>	205558	
	<b>MIP-HPT Screen Ratchet Wrench Assembly</b>	212094	
	<b>OIP Window Ratchet Wrench Assembly</b>	225140	
	<b>OIHPT-UV Power Supply</b>	228265	
	<b>OIHPT-G Power Supply</b>	231345	
	<b>HPT Sensor Module</b>	210091	
	<b>Band Clamp No. 7</b>	220976	Quantity: 10
	<b>Brass Barb MIHPT/OIHPT TL to HPT Sensor</b>	220978	Quantity: 5
	<b>Band Clamp No. 5</b>	220977	Quantity: 10
	<b>1.75 Connection Tube With Friction Reducer</b>	225827	2.13 in. OD
	<b>1.75 in. Connection Tube</b>	219594	
	<b>1.75 RHSL Box x 1.5 RHML Pin V1 Drive Head</b>	220545	1.75 Box x 1.5 Pin x 4.50 in S-S
	<b>1.75 RHSL Box x 1.5 RHML Pin V2 Drive Head</b>	250333	1.75 Box x 1.5 Pin x 4.50 in S-S
	<b>1.75 RHSL Box x 1.75 RHML Pin V1 Drive Head</b>	220130	1.75 Box x 1.75 Pin x 4.08 in S-S
	<b>1.75 RHSL Box x 1.75 RHML Pin V2 Drive Head</b>	247976	1.75 Box x 1.75 Pin x 4.08 in S-S
	<b>MIHPT/OIHPT/HTL Trunkline Seal, Red V1</b>	211768	Use with V1 Drive Heads
	<b>Trunkline Seal Spacers</b>	207596	Pair - Use with V1 Drive Heads
	<b>MIHPT Trunkline Seal, Black V2</b>	248787	Use with V2 Drive Heads
	<b>O-Ring (1.75 in. DI Probes)</b>	223575	Quantity: 10



Accessories

Components	Part	MN	Notes
	Electrical Vane Test Instrument/Gearbox	221266	
	Vane Transport Case - Instrument Motor	112835	
	Vane Instrument Mounting Ring	112889	
	Vane Log Logging Software for Windows	112836	
	Vane Power Cable	223010	12Vdc, 4A
	Vane Serial Cable	223014	RS232
	Vane Torque Wrench Control Instrument	112837	Optional for field confirmation
	Eurocode Field Vane	600468	65 mm x 130 mm
	2.25 in. Probe Rod	204778	1 m
		204777	12 in.
		206588	24 in.

Components	Part	MN	Notes
	Vane Inner Ext Rods (22 mm x 1000 mm)	112886	
	Adapter 2.25 Pin x Geotech SPT Pin	213295	Adapts Eurocode sheath to rods
	Vane Gearbox 2.25 in. Rod Clamp	221557	For mounting gearbox to casing
	Vane (65 mm x 130 mm)	600509	Vane Blade
	Vane (50 mm x 110 mm)	601086	Vane Blade
	Vane Slip Coupling	600510	
	Field Vane Sheath Seal	600497	Repair Part
	Vane Slip Coupling Rubber Boot	112261	Repair Part
	Vane Slip Coupling Needle Bearings	112683	Repair Part
	Vane Slip Coupling Pin	112684	Repair Part



Watch this video to learn about our dual flight anchors.

[geoprobe.com/anchoring](http://geoprobe.com/anchoring)

Single bridge with dual anchor



4-ft. bridge (2-anchor)



Accessories

Components	Part	MN	Notes
	CPT Rod Guide Assembly	239467	78/31 Series
	Soil Anchor Pinning Brackets	205209	Holds anchors against bridge
	Single CPT Bridge Weldment	231180	78/31 Series
	Soil Anchor Extension	235575	12 in. Spiral, Used for dual anchor
	Soil Anchor	235227	10 in. Spiral, 1.625 Hex
	Soil Anchor Extension	205072	60 in.
	Soil Anchor	235239	15 in. Spiral, 1.625 Hex
	CPT Anchor Bridge	239335	4 ft.
	CPT Anchor Footbridge	212131	Larger foot bridge
	HSA Auger Connecting Pin	600193	1-5/8 in. Hex, 77/66 Series Machines