

Direct Push Installation of Devices for Active Soil Gas Sampling & Monitoring

Technical Bulletin No. MK3098
Prepared: May, 2006

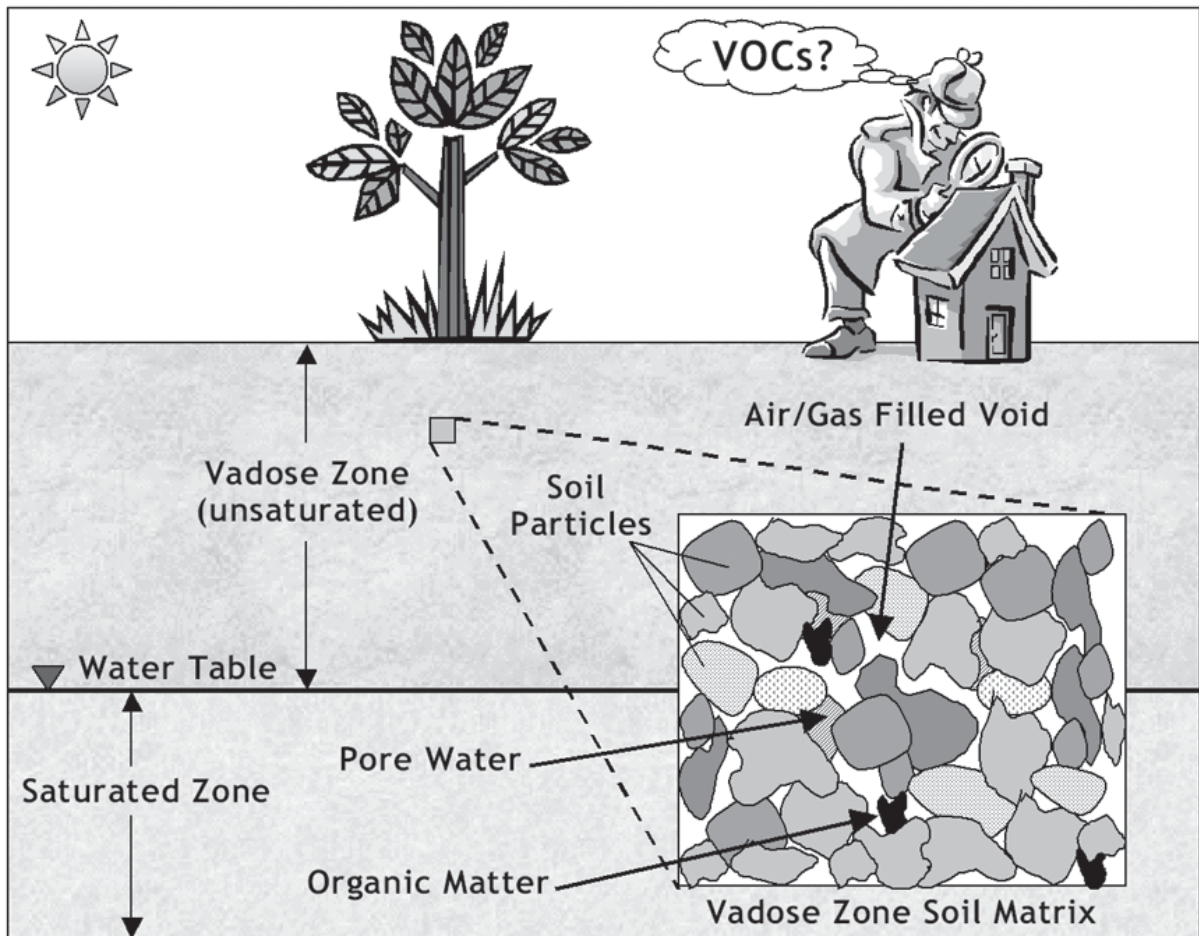

Section 1.0 Purpose

This document details the collection of representative soil gas samples with appropriate direct push (DP) methods to meet a range of data quality objectives, site-specific conditions, and regulatory requirements. New requirements for vapor intrusion investigations (U.S. EPA 2002, Cal. DTSC 2003, NYDOH 2005, etc.) establish higher sample data quality objectives to meet the needs for the human health risk assessment for this pathway. Downhole tools and sample collection methods needed to obtain the higher quality soil gas samples are reviewed.

Section 2.0 Background

What is soil gas? Where is the vadose zone? The ASTM Standard Guide D5314 for soil gas monitoring gives us the following definitions:

soil gas = vadose zone atmosphere

vadose zone = the hydrogeological region extending from the soil surface to the top of the principal water table

Soil gas is simply the gas phase (air) that exists in the open spaces between the soil particles in the unsaturated portion of the subsurface (Figure 1). Soil gas is normally comprised primarily of nitrogen and oxygen like the aboveground air it is in equilibrium with. However, when volatile organic compounds (VOCs) have been released in the subsurface due to spills or leaks, they will begin to evaporate from the fluid phase and become a part of the soil gas. Over time the VOCs can migrate through the soil and/or groundwater and present a potential hazard to human health or the environment. Intrusion of volatile contaminant vapors into an occupied building (home, office, school, etc.) can lead to exposure of the occupants to the potentially harmful contaminants (US EPA 2002).

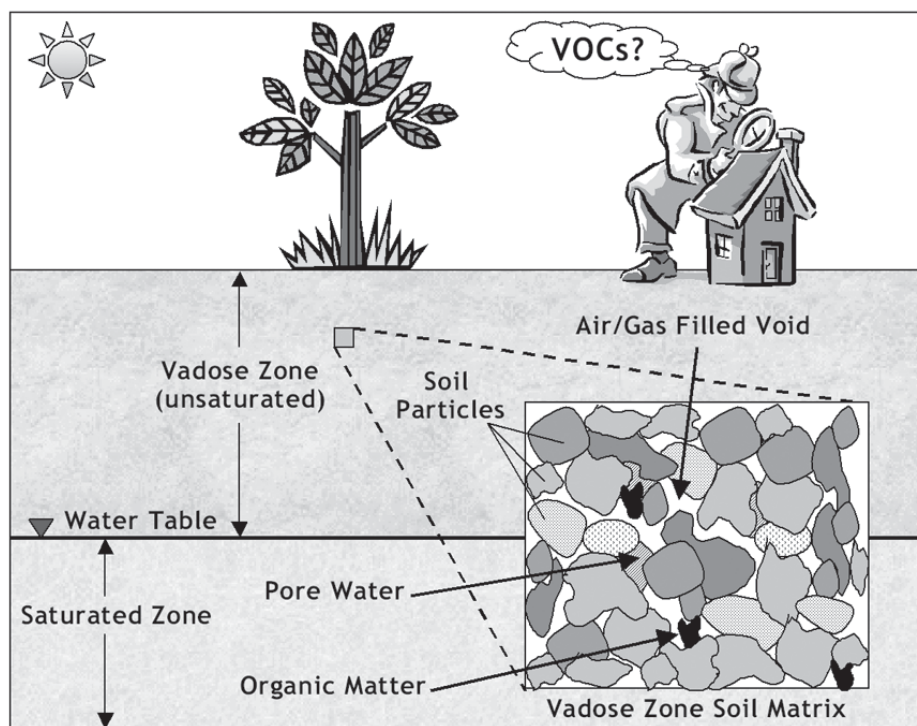

Figure 1: Schematic showing relationship of the vadose zone and saturated zone. Also exploded view showing the primary components of the soil matrix. VOCs will equilibrate with the solid, liquid, and gas phases of the soil matrix. Free product may also be present in the void space of the soil matrix.

Previously, soil gas sampling and monitoring were used primarily as cost- and time-effective means to track soil and groundwater contamination by VOCs and identify potential source areas (US EPA 1997). As our understanding of the vapor intrusion pathway develops, the use of soil gas data is being applied to evaluate this potential human health hazard. Because the vapor intrusion pathway deals with human health risk assessment, the sample and data quality objectives for soil gas samples are more stringent for this application than for simple plume tracking and source location activities. This technology overview will provide guidance on selection of the appropriate tools and methods for soil gas sampling and monitoring depending on the data quality objectives of the project.

It is useful to realize that VOCs will be partitioned between the different components (phases) of the vadose zone (Figure 1) (ASTM D5314, McCall et al. 2006) depending on their physical and chemical characteristics. The VOCs will be present in the soil gas phase, dissolved in any liquid water that may be present, and probably sorbed to the solid soil particles, especially any organic matter. Near the source of contamination, free product also may be present in the soil. The distribution of the contaminant(s) in different phases of the soil matrix is important to consider when sampling. If a strong vacuum is applied to the sample interval, VOCs that were partitioned into the liquid phase or sorbed to the solid matrix may be stripped and enter the vapor phase. This can result in an inaccurate measure of the amount of the contaminant actually in equilibrium with the vapor phase and lead to erroneous conclusions in a risk assessment.

3.0 VOCs and Other Soil Gases of Interest

The primary contaminants of interest in soil gas sampling and vapor intrusion studies are chlorinated volatile organic compounds (X-VOCs), aromatic compounds, and some landfill gases (Table 1). The volatility of a compound is primarily a function of its vapor pressure. The higher the compound's vapor pressure (Table 1) at ambient conditions the greater its volatility. This simply means any spilled liquid will quickly evaporate and enter the gas phase. If spilled on soil or leaked into the subsurface, a compound will tend to enter the soil atmosphere. Don't forget these compounds also will be partitioned into the other phases of the soil matrix (Figure 1). In general, compounds with vapor pressures greater than about 0.5 mm Hg are considered to be detectable with active soil gas methods.

At many sites, VOC releases will contaminate the groundwater and then migrate down gradient with the flowing groundwater. Over time these groundwater contaminant plumes can become sources for VOC migration into the overlying soil gas that may potentially become a vapor intrusion source. The Henry's Law constant of a compound is used to describe its tendency to partition between water and vapor. One way to determine the Henry's Law constant of a compound is to divide the equilibrium concentration of the compound in air by its concentration in water. This provides a unitless ratio. The higher the Henry's Law constant the more the compound tends to enter the gas phase. Usually compounds with Henry's law constants greater than 0.1 and sufficiently high vapor pressures are considered to be detectable with active soil gas sampling (EPA 1997).

4.0 Conceptual Site Model (CSM)

The conceptual site model (CSM) is a simplified picture and/or written description of what may be a complex system (U.S. EPA 2002). The purpose of the CSM is to provide the investigation team and other interested parties an initial idea about the subsurface conditions, possible contaminant migration pathways, potential receptors, local soils and geology, and potential sources for the volatile contaminants under investigation. The CSM should include preliminary site maps, geologic cross sections and other pertinent diagrams. This may include maps of sewer lines, water lines and other underground utility lines that may provide preferential conduits for migration of volatile contaminants to homes, schools, offices and other buildings where vapor intrusion could pose a health hazard. Sensitive environments and endangered species also should be evaluated.

A good CSM will help the investigation team identify additional information that will be required to complete the investigation and determine if the vapor intrusion pathway is complete. The CSM should be viewed as a dynamic tool that will be updated and modified as additional information, samples, and data are obtained that better characterize the site conditions. Soil samples may be required to verify local soil and geological conditions and identify potential source areas. Groundwater samples may be required to determine if a groundwater plume is acting as a source for volatiles across the site area and what the contaminant concentrations are. Measurements of hydraulic conductivity or soil permeability may be needed to evaluate the potential rate of contaminant migration. Several direct push methods are available to obtain these samples and other information needed to confirm or modify the CSM to accurately reflect site specific conditions. Direct push electrical conductivity logs, hydraulic profiling tool (HPT) logs, membrane interface probe (MIP) logs for volatiles, and CPT logs may provide methods to achieve a detailed site model in a relatively short time frame. In addition, ASTM Standards are available for particular methods and procedures for sampling and investigation that may provide useful insights and special knowledge. Some pertinent ASTM Standards particular to direct push methods include D6001, D6282, D6725, and D7242.

Section 5.0 Data Quality Objectives (DQOs) and Selection of Sampling Methods

As mentioned previously, the data quality objectives will determine how samples are obtained in the field and analyzed. The project manager and field team will have to determine which downhole tools are required and the specific sample collection and analysis methods that should be used to meet the DQOs of the project. But first, what are data quality objectives? DQOs are basically a set of rules that define the amount of uncertainty that is acceptable in the results obtained from an environmental investigation. How confident are you that the sample you collected is representative? Are you sure the analytical method applied accurately identifies the contaminant and what its concentrations are in the sample?

One of the first steps in determining your DQOs is to clearly define the regulatory requirements that must be met to determine if the potential hazard (e.g. vapor intrusion) is an actual threat to the population of concern. Review the state or federal regulations and guidance documents (Cal RWQCB 1997, Cal. DTSC 2003, NYDOH 2005, U.S. EPA 2002, etc.) to be sure you know what is required and how the data is to be used. The following outline of objectives for three different projects may help clarify where and when different levels of data quality are required.

Project 1:

- Are VOCs present in soil gas?
- What are gross concentration ranges?
- What is approximate extent of the contamination?

Project 2:

- What are the specific types of VOCs present in the soil gas?
- What are approximate concentrations of each contaminant type at each location?
- Define and map the extent of the contaminant plume and locate source areas.

Project 3:

- Determine the specific VOC compounds present in the soil gas.
- Determine the concentration of each compound at each location with good precision and accuracy.
- Define and map the plume for each analyte and locate sources.
- Determine if the contaminants present a threat to human health or the environment (is the vapor intrusion pathway complete?).
- Obtain data that can be used to determine appropriate remedial actions or if remedial actions are required.

Once you determine what level of data quality is required you can then determine the appropriate sampling tools, sample collection procedures, and analytical methods that are required to meet your objectives. Table 2 may be used to guide you in selecting the appropriate methods to use in the field to be sure the project manager, facility owners, and regulators are able to make the correct decisions. **Establishing project DQOs and selecting the appropriate field methods for sample collection and downhole tool systems is not a trivial process and should be completed well in advance of starting field work.** Details of the sample collection methods and downhole sampling systems listed in Table 2 are discussed in the following sections.

Of course the final data quality is controlled by the analytical method chosen and the analytical quality control that is used. You can collect a low quality sample and spend hundreds of dollars on an expensive analytical method with rigorous quality control, this would be a mistake. If you have low confidence in the sample quality (poorly representative) it will not matter how much you spend on the analysis, the final data will still be of low quality (poorly representative). You can't improve the quality of a bad sample by using expensive analytical methods. In the end the analytical result is only as good as the sample quality. For guidance on selection of the appropriate analytical methods review the appropriate federal or state guidance documents (Cal RWQCB 1997, Cal. DTSC 2003, NYDOH 2005, U.S. EPA 2002, etc.) and/or the SW846 manual (EPA 1986).

5.1 Analytical Methods

The EPA Draft Guidance for the vapor intrusion pathway includes a table listing more than a dozen analytical methods used to test for VOCs. The purge and trap methods such as 8260C were primarily written for soil and groundwater analysis. Purge and trap methods may be useful if you are conducting passive soil gas sampling and collecting VOCs in a sorbent trap. However, direct injection may be conducted with method 8260C and this provides a useful method for analysis of soil gas samples. Method TO-17 is also a method that requires the use of a sorbent trap for sample collection and later purge and trap gas chromatograph (GC) analysis. This is sometimes used for ambient air monitoring in buildings.

(continued on Page 6)

Table 1: Basic chemical properties^{A,B,C,D} of selected VOCs and gases of interest in soil gas investigations.

Chemical Name	Molecular Formula	Molecular Weight	Density (g/cc)	Henry's Law Constant Ratio ^c (atm·m ³ /mol) ^a	Boiling Point (°C)	Water Solubility % ^a (g/L @ 25°C) ^b	Vapor Pressure (mm Hg @ 68°F)	Viscosity ^a (mPa·s @ 25°C, 1 atm)	Ionization Potential (eV)
Aromatics and Aliphatics									
Benzene	C ₆ H ₆	78.11	0.877	0.215	176°F	0.04% @ 54°F (1.77)	75	0.604	9.24
Toluene	C ₆ H ₅ CH ₃	92.1	0.87	0.262	232°F	0.05% @ 61°F (0.53)	20 (at 65°F)	0.56	8.82
Ethyl Benzene	C ₆ H ₅ CH ₂ CH ₃	106.2	0.87	0.322 (8.5E-3)	277°F	0.01% (0.16)	10 (at 79°F)	0.631	8.76
Xylenes (o,m,p isomers)	C ₆ H ₄ (CH ₃) ₂	106.2	0.88 to 0.86	0.304	269°F to 292°F	~0.01% (0.16 to 0.18)	7/9/9	0.760, 0.581, 0.603	8.44 to 8.56
(n-)Octane	CH ₃ (CH ₂) ₆ CH ₃	114.2	0.70	---	258°F	~insoluble	10	0.508	9.82
Methyl t-butyl ether (MTBE) ^d	CH ₃ C(CH ₃) ₂ OCH ₃	88.15	0.74	0.018 (5.5E-4)	55.2	(51.2)	245	---	---
Chlorinated VOCs									
Vinyl Chloride	CH ₂ CHCl (chloroethene)	62.5	0.911	(1.1E-2)	-13.3 (7°F)	~0.1% @ 77°F (2.8)	>760	---	9.99
1,1-Dichloroethane (1,1-DCA)	CHCl ₂ CH ₃	99.0	1.18	---	135°F	0.6%	230mm (at 77°F)	0.464	11.06
1,2-Dichloroethylene (1,2-DCE)	(CH ₂)Cl ₂ (1,2-DCE)	97.0	1.27 (at 77°F)	(3.0E-2)	118° to 140°F	0.4% (2.4)	180 to 264	Cis = 0.445 Trans = 0.317	9.65
1,1,2-Trichloroethane	CHCl ₂ CH ₂ Cl (TCA)	133.4	1.44	---	237°F	0.4% (4.4)	19	---	11.0
Trichloroethylene (TCE)	ClCH=CCl ₂ (TCE)	131.4	1.46	---	189°F	0.1% @ 77°F	58	0.545	9.45
Tetrachloroethylene (Perchloroethene)	Cl ₂ C=CCl ₂ (Perchloroethene)	165.8	1.62	---	250°F	0.02% @ 77°F (1.2)	14	0.844	9.32
Carbontetrachloride	CCl ₄	153.8	1.59	---	170°F	0.05% (1.2)	91	0.908	11.47
Landfill Gases									
Methane	CH ₄	16.04	0.4228 ⁻¹⁶²	---	-161.5	Soluble	-	---	12.98
Carbon dioxide	CO ₂	44.0	---	---	sublimes	0.2% @ 77°F	>760	---	13.77

g/cc = grams per cubic centimeter. atm·m³/mol = atmosphere cubic meter per mole. °C = degrees centigrade. °F = degrees Fahrenheit. g/L = grams per liter.

mm Hg = millimeters of mercury. mPa·s = millipascal second = centipoise. atm = atmosphere. eV = electron volt

A) NIOSH Pocket Guide to Chemical Hazards, 1990. B) CRC Handbook of Chemistry and Physics, 1995. C) U.S. EPA, 1997. D) www.epa.gov/opptintr/chemfact/s_mtbe.txt

Table 2: Matrix for selection of field methods to achieve DQOs.

Downhole Sampling System		Sample Collection Method			
		Syringe	Tedlar Bag	Glass Bulb	Summa Canister
	<i>Increasing Quality</i>				
Direct Sampling	↓	<i>Low / Low</i>			<i>Low / High</i>
PRT System					
Implants					
Gas Wells		<i>High / Low</i>			<i>High / High</i>

Dashed arrow shows general path for selection of methods that will result in sampling and collection with compatible quality procedures to achieve desired DQO level. If method pairs in the upper right or lower left corner are used the final sample analytical quality will be of low confidence regardless of the analytical method applied. To achieve intermediate DQOs for an initial survey the PRT system is often combined with collection in Tedlar bags or glass sampling bulbs and field analysis utilizing a mobile lab equipped with a gas chromatograph.

For active soil gas sampling you will probably be involved with one or more of the following methods:

Method #	Analytes	Instruments	Det. Limits
8260	Aromatic, Halogenated and other VOCs	GC/MS	50 ug/m ³
8260 SIM	Aromatic, Halogenated and other VOCs	GC/MS	10 ug/m ³
8021	Aromatic and Hologenated VOCs	PID/ELCD-GC	> 5 ug/m ³
TO-15	VOCs in Air with Summa Canisters	GC/MS	1 to 10 ug/m ³
TO-17	VOCs in Air with Sorbent Tubes	GC/MS	0.5 to 25 ppbv

GC = Gas Chromatograph MS = Mass Spectrometer PID = Photo Ionization Detector
ELCD = Electrolytic Conductivity Detector

The 8021 Method is often modified for use in a mobile lab in the field. Air samples are direct injected on column for analysis. Sometimes an ECD (electron capture detector) is used instead of the ELCD(electrolytic conductivity detector) to detect the chlorinated VOCs. Field analysis with the 8021 method allows the field team to track/map plumes while in the field and locate source areas. The field analysis is also a useful way of screening samples to determine which are best submitted for more expensive off-site analysis. Knowing approximate sample concentrations also may be used to select the appropriate lab analysis.

For soil gas samples with elevated concentrations the standard 8260 method will provide sufficient sensitivity and detection limits. Samples with lower concentrations may be suitable for the 8260 SIM (selected ion monitoring) method. Low concentration samples requiring lower detection limits and high data quality may require the TO-15 method. Be aware that not all labs provide the same level of data quality for the same method. A cheaper price may mean less QA/QC. Be sure the final data package will meet your data quality requirements.

Section 6.0

Downhole Soil Gas Sampling Methods for Preliminary Assessments and Plume Tracking

6.1 Methods to Advance Tool Strings

Several methods for soil gas sampling were developed in the 1980s and used to track VOC plumes and locate potential source areas. One of the earlier methods included manually driving galvanized steel pipe to the desired depth with a slam-bar or fence-post-driver. While physically demanding, these manual methods may still prove valuable in accessing delicate ground in residential areas (landscaped plant beds, etc.) or where access is otherwise limited. Improvements to this manual method have been made to improve sample quality and minimize the physical demands for driving and removing the probe rods (Figure 2) (Geoprobe Systems®, 2001). When site access conditions permit, soil gas sampling tools may be advanced into the subsurface with a Geoprobe® direct push machine (Figure 3) to minimize the physical effort required and speed up the sampling process.

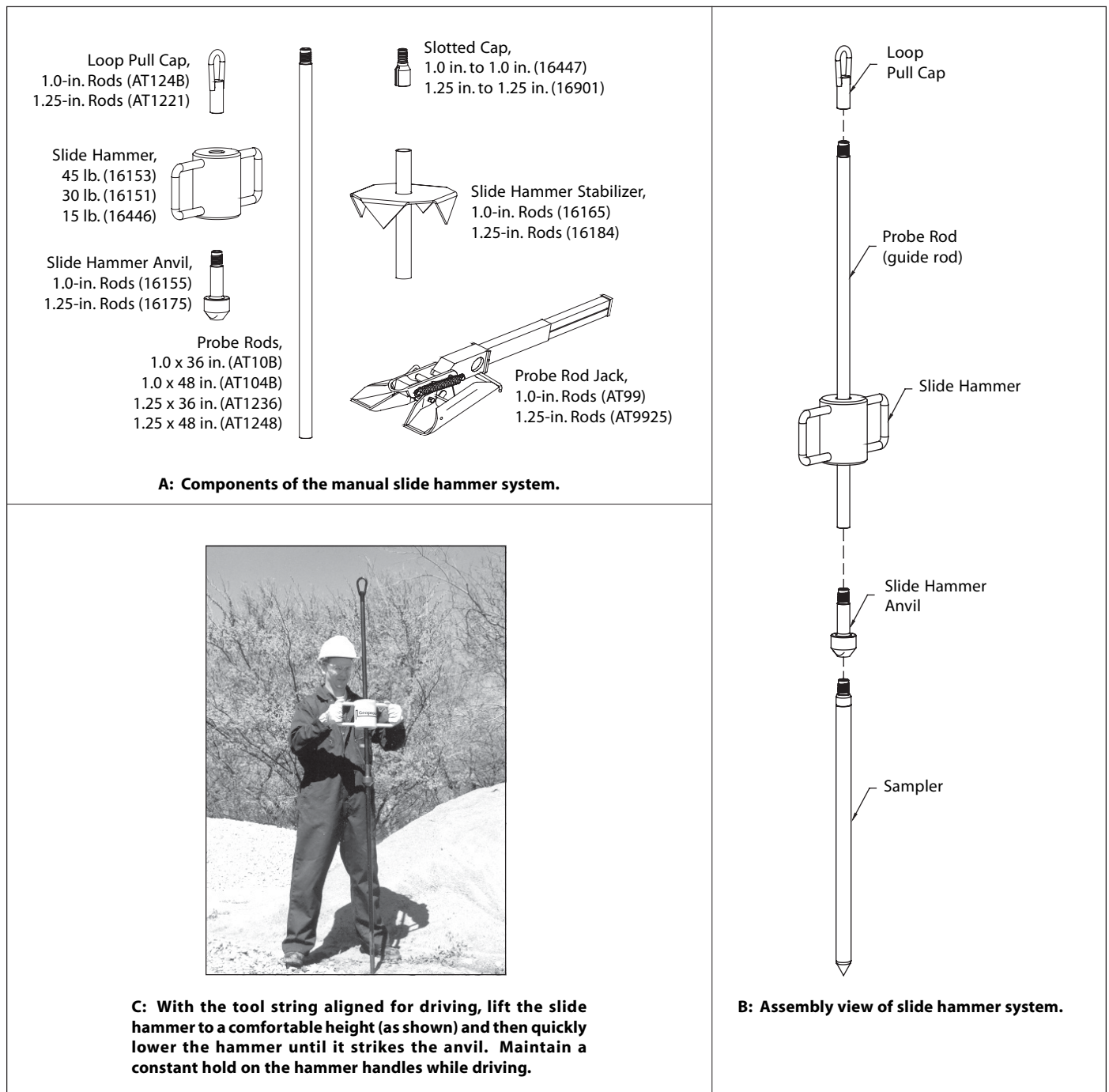

Figure 2: Components, assembly, and operation of the manual sampling tools.

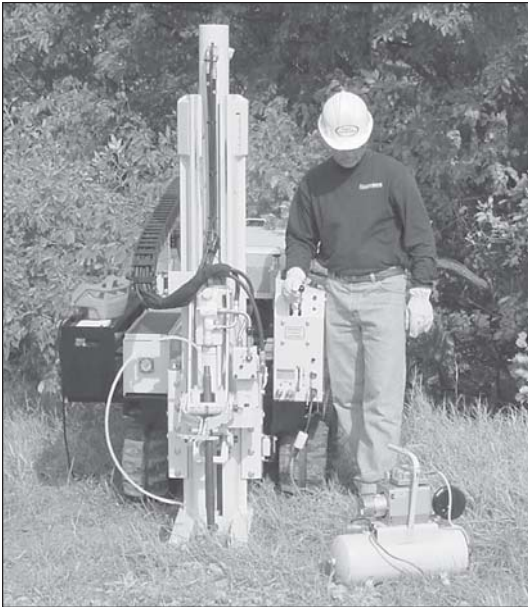

Figure 3: Using a Geoprobe® direct push machine to advance soil gas sampling tools to depth. Note use of portable vacuum/volume system for purging and sampling.

6.2 Direct Sampling System

Initially the collection of soil gas samples was conducted directly through the rods driven to depth (Figure 4). An expendable point was advanced to depth on the leading end of the drive rods. Then the rods were retracted a specified distance to release the expendable point and create an open void where soil gas could enter the rod string for sampling. A gas sampling cap with appropriate fitting was attached to the top of the drive rods and gas was purged and then collected for analysis. While this method is quick and cost effective there is potential for leaks at each rod joint that could compromise sample quality. This method also requires that the steel rods be thoroughly decontaminated between each use. In addition, some contaminants may be sorbed or degraded on the metal surface of the drive rods, especially if the rods are rusty.

6.3 PRT Sampling System

The Post Run Tubing (PRT) system was developed to help eliminate some of the problems with sampling directly through the steel rods. The PRT method uses an adapter and tubing to isolate the soil gas sample from the steel drive rods (Figure 5). This also eliminates possible leaks of ambient air from the rod joints into the gas being sampled. Tool configurations for soil gas sampling with the PRT system using different size probe rods are shown in Figure 6. PRT adapters (Table 3) must be selected to fit the desired tubing (Table 4) that will be used for sample collection.

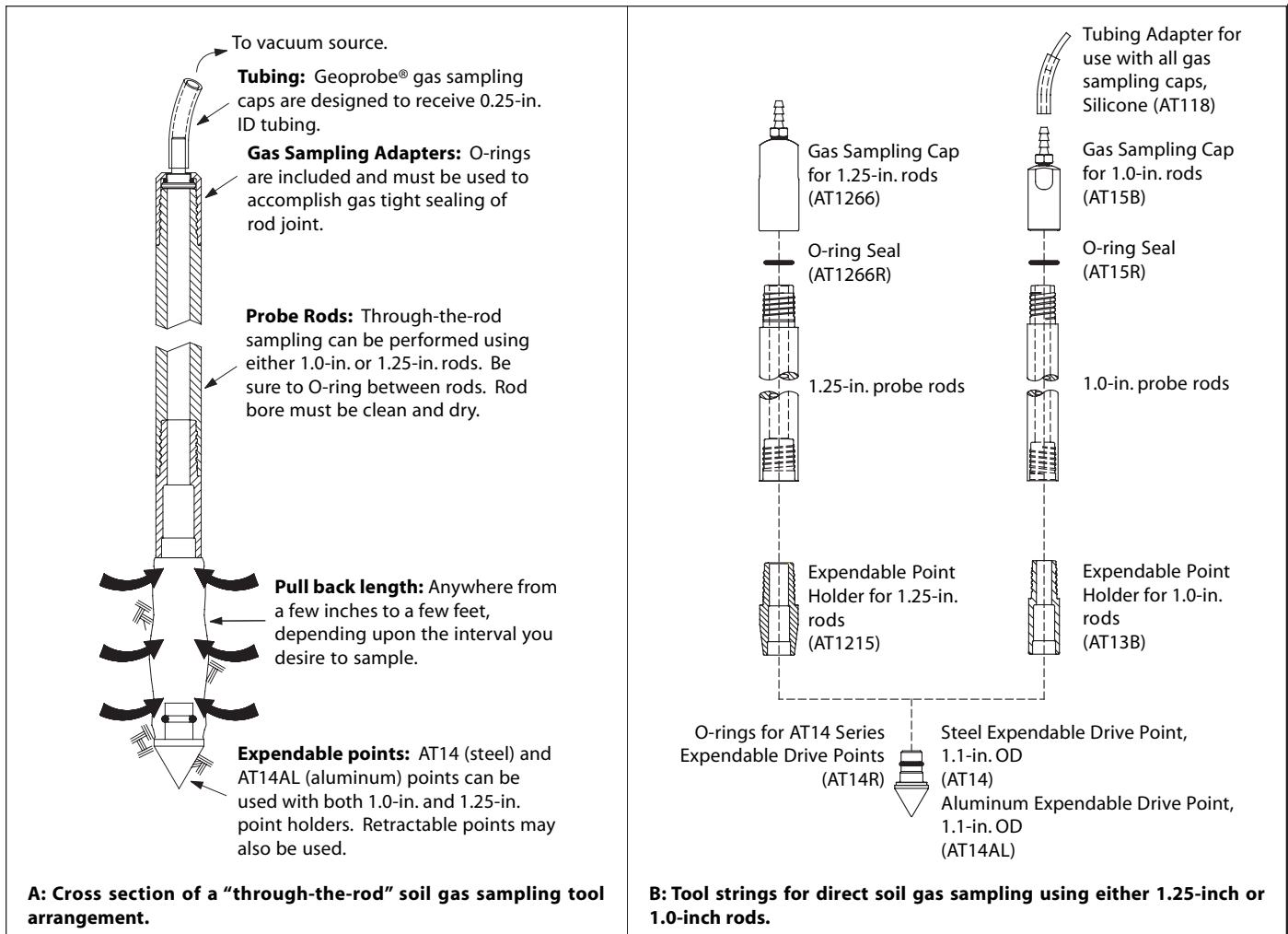

Figure 4: Direct sampling systems.

The basic steps to conduct soil gas sampling with the PRT system are as follows:

- An expendable point holder is attached to the lead rod.
- The expendable point is placed in the point holder, use O-ring.
- The tool string is advanced to the desired sampling depth. Additional probe rods are added as required.
- Next, the stainless steel PRT adapter with appropriate sized barb is attached to the selected tubing cut to length.
- The drive cap is removed from the tool string and the PRT Adapter is lowered on the tubing down the tool string.
- The PRT adapter is threaded into the reverse thread fitting in the top of the PRT expendable point holder by manually rotating the tubing counterclockwise until the O-ring on the adapter seals against the point holder. The top end of the tube may be sealed to minimize gas exchange with the ambient air and possible loss of VOCs.
- A leak test of the PRT tubing system may be conducted at this time by applying vacuum to the tubing. An in-line gauge may be used to verify that leaks do not occur after the vacuum is applied.
- The direct push machine is then used to retract the probe rods a specified interval, usually 6 to 12 inches (or 150 to 300 mm). This provides an open cylinder in the soil through which the soil gas may be purged and sampled.
- The upper end of the tube is connected to the purging/sampling system and the sample is collected.
- The direct push machine is used to remove the probe rods. Once at the surface, the O-ring seal between the PRT adapter and the expendable point may be visually inspected to further verify sample integrity.

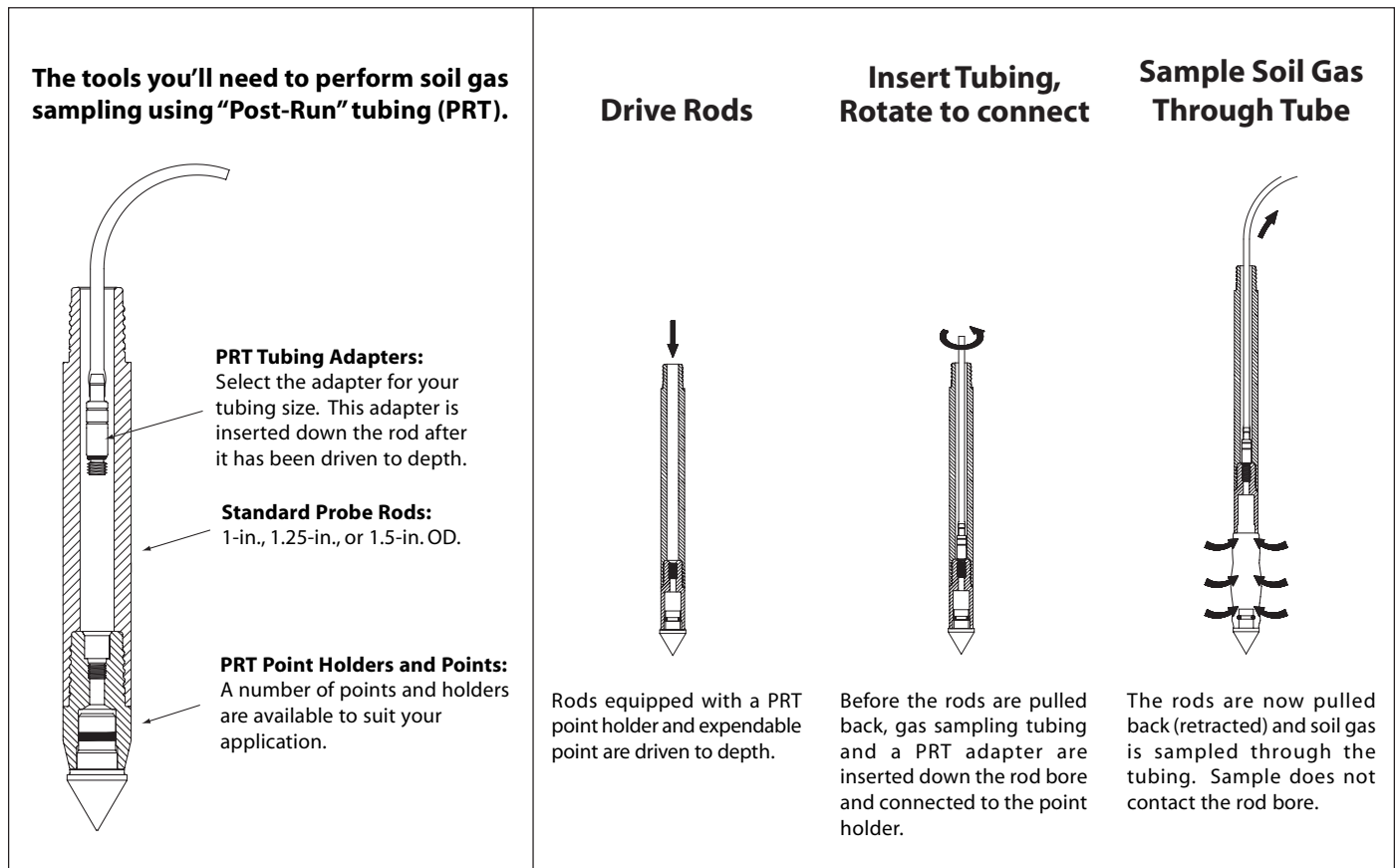

Figure 5: PRT sampling system.

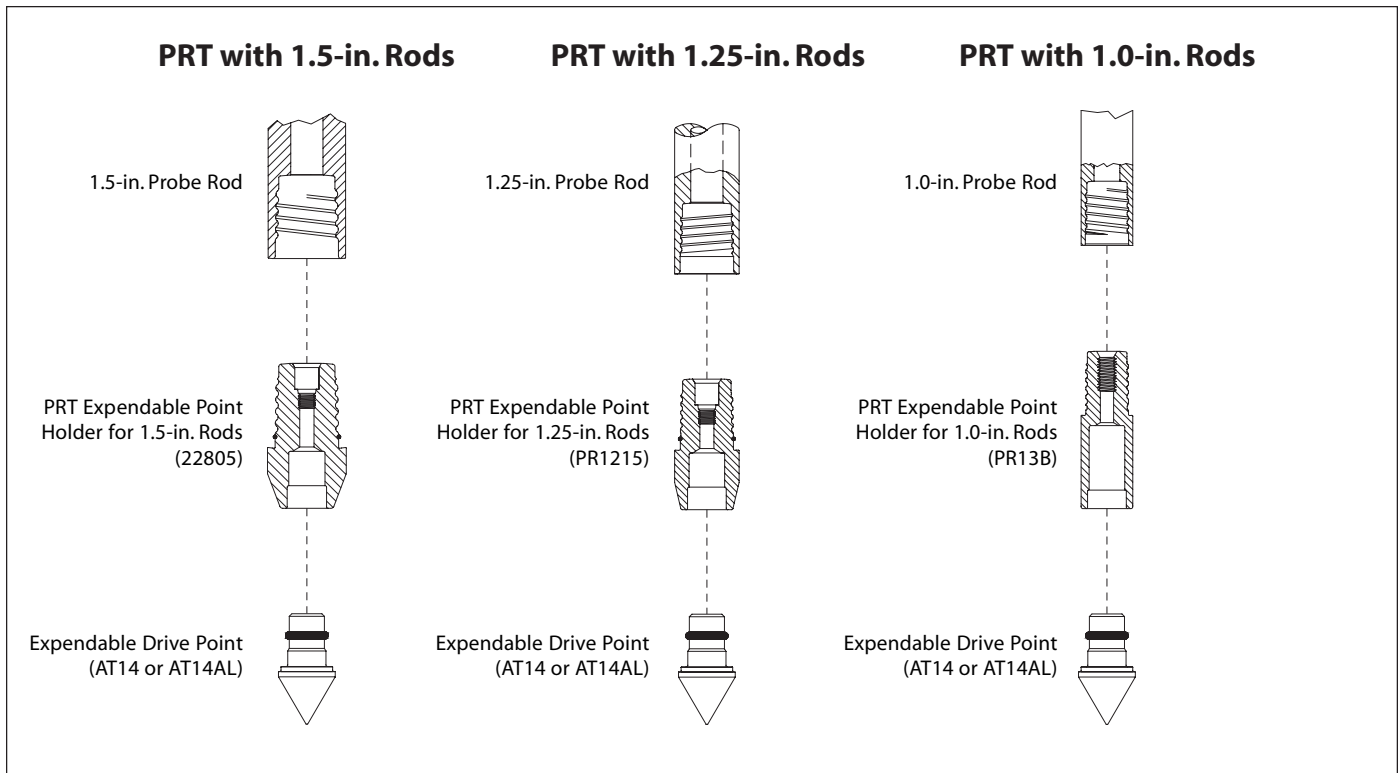







Figure 6: Tool configurations for PRT soil gas sampling.

Table 3: PRT adapter selection guide.

PRT Adapter Selection Guide			
PRT ADAPTER and PART NUMBER	RECOMMENDED TUBING SIZE (ID)	GEOPROBE® TUBING PART NO.	TUBING INTERNAL VOLUME
 PR125	1/8 in. (3.2 mm)	TB12T Teflon®	2.4 mL/ft (7.9 mL/m)
 PR175	0.17 in. (4.3 mm)	TB17L LDPE	4.5 mL/ft (14.6 mL/m)
	3/16 in. (4.8 mm)	TB17T Teflon®	5.4 mL/ft (17.8 mL/m)
 PR255	1/4 in. (6.4 mm)	TB25L LDPE	9.7 mL/ft (31.7 mL/m)
 PR305	5/16 in. (7.9 mm)	TB30T Teflon®	15.1 mL/ft (49.5 mL/m)
 O-Rings for all PRT Adapters PR25R (pack of 25)			

NOTE: The sorption characteristics of certain tubing may not permit their use in all soil gas sampling applications.

Table 4: Tubing selection guide for PRT adapters and soil gas implants.

Part Number	Tubing Material	Inside Diameter, inches (mm)	Outside Diameter, inches (mm)	Wall Thickness, inches (mm)	Length, feet (m)	Tubing Internal Volume, mL/ft (mL/m)	PRT Adapter Part Number	Implant Part Numbers ¹
TB17L	LDPE ²	0.17 (4.8)	1/4 (6.4)	0.040 (1.0)	500 (152)	4.5 (14.6)	PR17S	AT8617S AT8717S
TB25L	LDPE ²	1/4 (6.4)	3/8 (9.5)	1/16 (1.6)	500 (152)	9.7 (31.7)	PR25S	AT8625S AT8725S
TB37L	LDPE ²	3/8 (9.5)	1/2 (12.7)	1/16 (1.6)	100 (31)	21.7 (71.2)	NA	AT9637 ³ AT9638 ⁴
TB12T	Teflon [®]	1/8 (3.2)	1/4 (6.4)	1/16 (1.6)	50 (15)	2.4 (7.9)	PR12S	AT8612S AT8712S
TB17T	Teflon [®]	3/16 (4.8)	1/4 (6.4)	1/32 (0.8)	50 (15)	5.4 (17.8)	PR12S	AT8612S AT8712S
TB30T	Teflon [®]	5/16 (7.9)	3/8 (9.5)	1/32 (0.8)	50 (15)	15.1 (49.5)	PR30S	AT8630S AT8730S
TB45SL	Silicone	3/16 (4.8)	7/16 (11)	1/8 (3.2)	25 (8)	-	NA	NA
TB50TY	Vinyl	1/4 (6.4)	7/16 (11)	3/32 (2.4)	25 (8)	-	NA	NA
TB100TY	Vinyl	1/4 (6.4)	7/16 (11)	3/32 (2.4)	100 (31)	-	NA	NA
AT82	Stainless Steel	0.085 (2.2)	1/8 (3.2)	0.040 (1.0)	50 (15)	-	NA	AT86SW12

1 - 86 series implants are 6 in. (152 mm) long and 87 series implants are 21 in. (533 mm) long.

2 - Low-density polyethylene.

3 - 96 series implants are for use in 1.25-in. or 1.5-in. OD probe rods with an ID of 0.625 in. (15.9 mm). Screen is 12 in. (305 mm) long. Use with any plastic tubing with an ID ranging from 1/4 in. to 7/16 in. (6.4 mm to 11 mm).

4 - This implant is designed for air sparging only and is equipped with a porous polyethylene lining.

6.4 Vapor Implants / Small ID Rods

These simple devices allow the investigator to install a small screen at the desired depth to conduct long-term monitoring of soil gas in the subsurface. The implants may be installed through 1.0-, 1.25-, or 1.5-inch outside diameter probe rods for many applications. However, when installed through these smaller rods it may not be possible to achieve the high-integrity seal required for human health risk assessments as in evaluation for the vapor intrusion pathway. High-integrity seals can be obtained by installing the implants through larger diameter rods as discussed later in Section 7.0.

The implants consist of a stainless steel wire mesh screen with a threaded fitting on the bottom for anchoring and a fitting at the top to connect to tubing (Figure 7). The AT86 series screens are 6 inches (152 mm) long, the AT87 series screens are 21 inches (533 mm) long, and both have an OD of less than 0.5 inches (13 mm). The AT96 series screens are 12 inches (305 mm) long with an OD of less than 0.625 inches (16 mm). All have a pore diameter of approximately 0.006 inches (0.15 mm) in the stainless screens (Table 5).

The implants are installed through the drive rods after they are advanced to the desired depth (Figure 8). An expendable implant anchor/drive point at the lead end of the rod string has a threaded fitting at the upper end and the implant is anchored in place by threading in counterclockwise. As the rods are retracted with the direct push machine, fine glass beads (P/N AT84) may be poured in around the screen to prevent clogging. Once the rods are above the screen, a bentonite powder mix (P/N AT85) may be added to the rod annulus to seal the probe hole. Do not hydrate the bentonite until the rod string is completely removed from the ground. The tubing should be capped to prevent venting to the ambient atmosphere until ready for sampling. A simple PVC pipe with cap may be installed over the implant tubing at the surface for protection. Conventional well protectors (P/N WP1771 or WP1741) may be used if necessary.

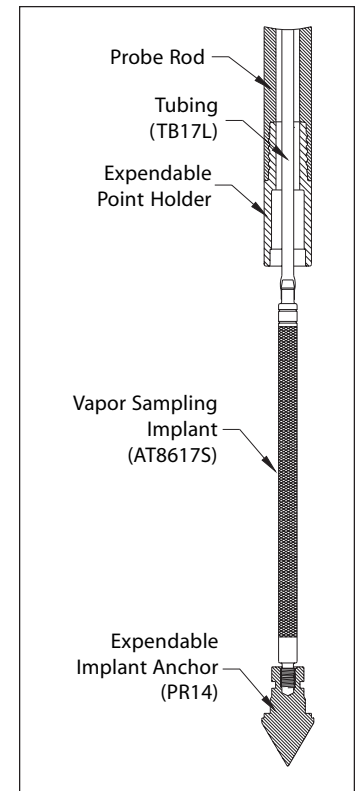

Figure 7: Schematic of a soil gas implant assembly.

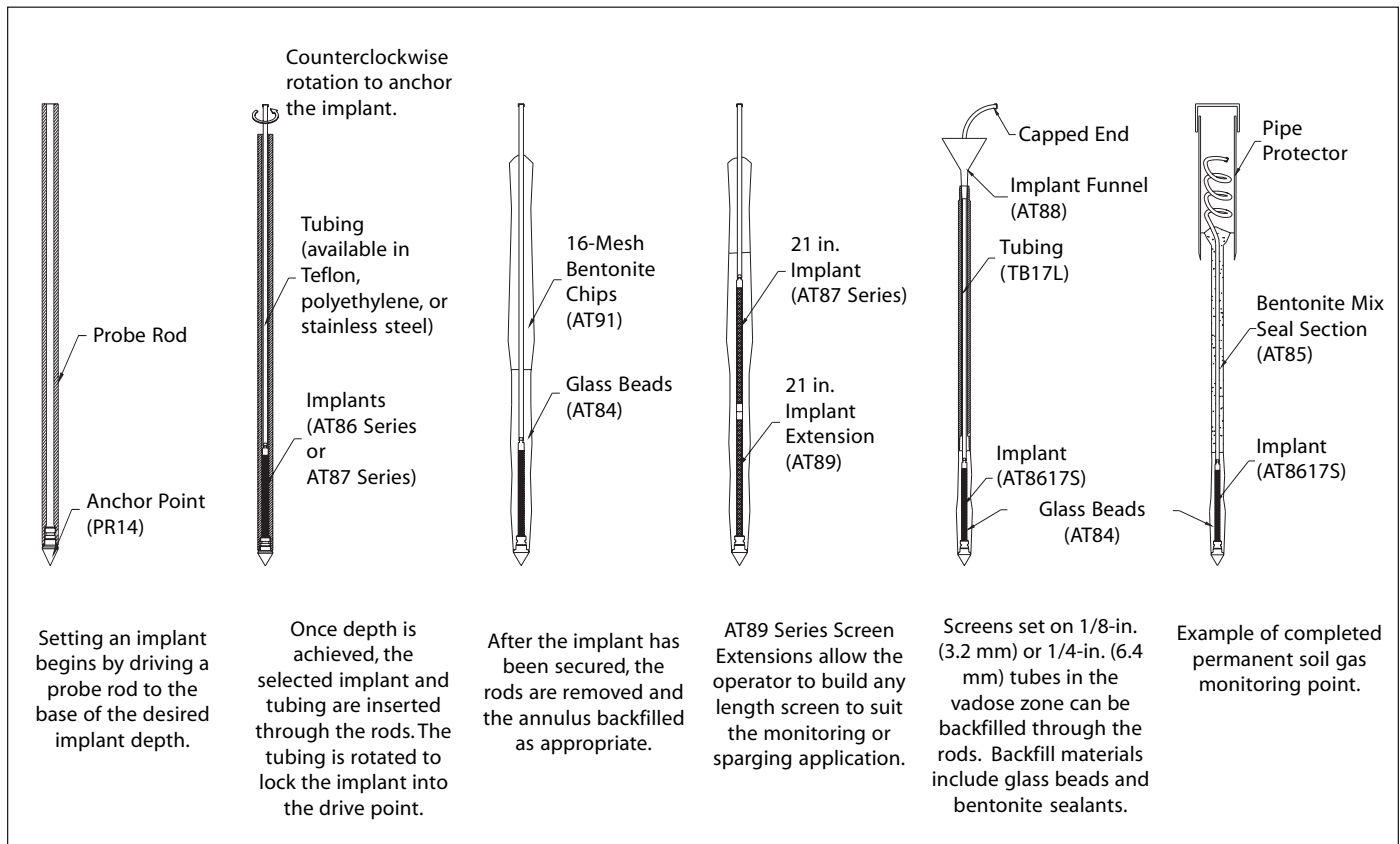









Figure 8: Installing implants through small-diameter probe rods.

Table 5: Implant selection guide.

END FITTING	SUGGESTED SAMPLING USE	RECOMMENDED TUBING SIZE	GEOPROBE® TUBING PART NO.	IMPLANT PART NUMBERS	
				6-in. (152 mm) SCREEN LENGTH	21-in. (533 mm) SCREEN LENGTH
 Barbed	Soil Gas	1/8 in. ID (3.2 mm ID)	TB12T	AT8612S	AT8712S
 Barbed	Soil Gas	0.17 in. ID (4.3 mm ID)	TB17L	AT8617S	AT8717S
		3/16 in. ID (4.8 mm ID)	TB17T		
 Barbed	Soil Gas, Shallow Groundwater	1/4 in. ID (6.4 mm ID)	TB25L	AT8625S	AT8725S
 Barbed	Soil Gas, Shallow Groundwater	5/16 in. ID (7.9 mm ID)	TB30T	AT8630S	AT8730S
 Swagelok™	Soil Gas	1/8 in. OD (3.2 mm OD)	AT82 (1/8 in. stainless)	AT86SW12	—
		3/16 in. ID (4.8 mm ID)	—	AT86SW17	—
		1/4 in. OD (6.4 mm OD)	—	AT86SW25	AT87SW25
 PRT Socket	Soil Gas, Shallow Groundwater	Screen Extension (for use with AT87 Series Implants)			AT89
For 1.25-in. and 1.5-in. Probe Rods Only		RECOMMENDED TUBING SIZE	GEOPROBE® TUBING PART NO.	12-in. (305 mm) SCREEN LENGTH	
 Tapered Screw Thread	Soil Gas, Shallow Groundwater, Air sparging (AT9638)	Any plastic tubing 1/4 in. ID to 7/16 in. ID (6.4 mm to 11 mm ID)	TB37L	AT9637 (sampling) AT9638 (sparging)	

AT86 Series: Screen is 0.25 in. ID x 6 in. long (6.4 mm x 152 mm) with 0.15 mm pore openings. AT86 implants will fit through 0.5-in. (12.7 mm) bore tooling.

AT87 Series: Screen is 0.25 in. ID x 21 in long (6.4 mm x 533 mm) with 0.15mm pore openings. AT87 implants will fit through 0.5-in. (12.7 mm) bore tooling.

AT9637 and AT9638 Implants: Screen is 3/8 in. ID x 12 in. long (9.5 mm x 305 mm) with 0.15mm pore openings. These implants require a minimum 0.625-in. (15.9 mm) rod bore for passage.

AT9638 implants are the only implants recommended for gas sparging (injection) as they have a porous polyethylene lining inside the implant screen. This interior filter prevents the implant from clogging with formation fines which may backflow into standard implants during periods of pressure shut down.

6.5 Soil Gas Profiling with Dual Tube Systems

In some situations it may be necessary to conduct vertical profiles of soil gas to determine if there is a significant change in concentration or contaminant type with depth. The methods discussed in previous sections could be used to obtain profiles, but a separate advancement would be required for each depth interval. Conversely, dual tube systems can provide access to soil gas or ground water at multiple depths during a single advancement of the tool string. The DT325 soil sampling system can be combined with a simple screen to conduct profiles of soil gas or groundwater if necessary (Figure 9). A summary of the procedure for soil gas profiling follows:

- The equipment operator may conduct continuous soil sampling as the tool string is advanced or install a solid drive point (P/N 28509) if soil sampling is not required.
- Once the cutting shoe is immediately above the desired soil gas sampling interval, the sample sheath and soil sample or solid drive point is removed.
- The profiler screen assembly (Figure 9) with a 12-inch (305 mm) screen (P/N 14402) or 6-inch (152 mm) screen (P/N 14401) is then attached to the inner drive rods and lowered through the annulus of the 3.25-inch rods.
- The screen is pushed through the open cutting shoe and advanced into the formation until the O-ring on the profiler head (P/N 21379) seals in the throat of the cutting shoe.
- At this point the tubing adapter (P/N 13521) is attached to the selected tubing (Table 4) and lowered through the bore of the inner rods.
- The inner tube and adapter are rotated counterclockwise to thread the tubing adapter into the top of the screen drive head (P/N 12567 or 16913).
- This then provides a sealed sampling system for collection of soil gas samples.
- Once the soil gas sample is collected, the tubing is removed and the inner rods and screen are retracted and removed.
- To advance to the next depth, either the solid drive point is installed in the cutting shoe or a soil sample barrel is installed for the next interval. The tool string is advanced to the next desired depth (with removal of soil cores as necessary).
- Installation of the screen and tubing is repeated for the next soil gas sample (Figure 9, Steps C and D).

Once the soil gas profiling is complete, it is possible to install permanent implants at multiple depths as the 3.25-inch rod string is retracted. See Section 7.3 for further discussion of this procedure. Be sure to soil core through any intervals where soil gas implants are to be installed. This will help minimize compression of the formation and loss of gas permeability. If permanent implants will not be installed, abandon the probe hole as required by local regulations (see Section 9.0).

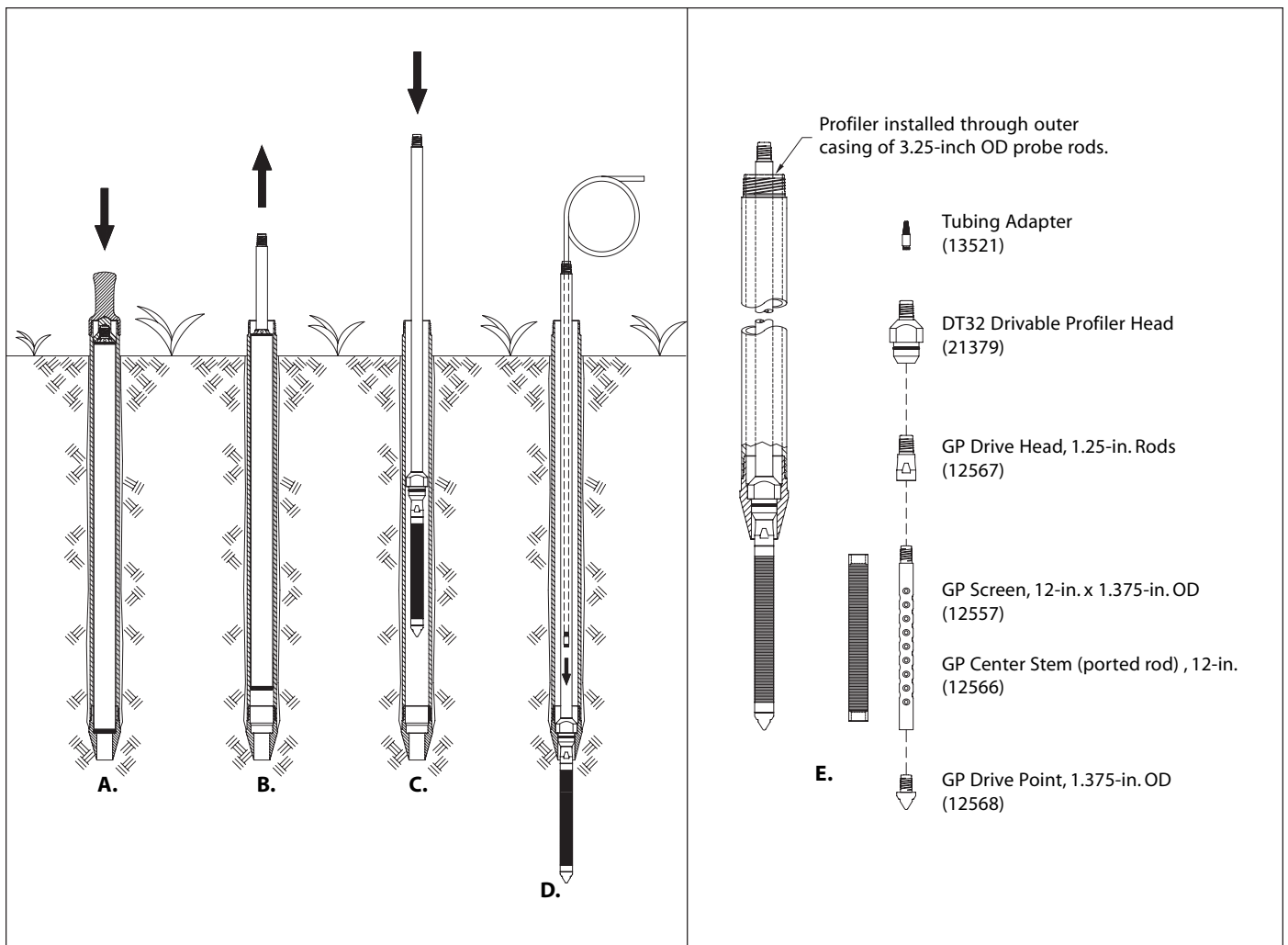

- A. Soil sampling as the tool string is advanced to minimize compression of the soil and loss of gas permeability.
- B. Extracting the soil sample.
- C. Installing the profiler screen through the rod bore.
- D. The selected tubing (Table 4) with attached tubing adapter (P/N 13521) are lowered through the bore of the inner rod string and threaded into the Screen Drive Head (P/N 12567). The soil gas is purged and sample is collected.
- E. Components of the profiler screen assembly for use with the DT325 system. The 12-inch (305 mm) screen assembly is shown here (P/N 14402). A 6-inch (152 mm) screen assembly (P/N 14401) is also available .

Figure 9: Soil gas profiling with the DT325 system.

Section 7.0

Downhole Soil Gas Monitoring Methods for Evaluation of the Vapor Intrusion Pathway

Data obtained for evaluation of the vapor intrusion pathway (VIP) will generally be used to conduct a human health risk assessment (HHRA). Because the data will be used for a HHRA, the data quality objectives are very high and most of the soil gas sampling methods described in previous sections may not meet the sample quality requirements. To achieve the higher DQOs and to permit long-term monitoring of soil gas, most regulatory agencies are requiring the use of permanent soil gas monitoring wells or implants with filter media around the screens and high-integrity seals. In some situations, multilevel monitoring is required to define the vertical distribution of soil gas in the subsurface and evaluate the potential for contaminant degradation. The following sections outline some field methods that will enable the investigator to achieve the higher DQOs when either single-level or multilevel monitoring of soil gas is required.

7.1 Single-Depth High-Integrity Soil Gas Implants for Monitoring

If the installation of implants with smaller probe rods as described previously will not meet the higher DQOs for your project, the DT21 dual tube system may be required. This system uses 2.125-inch (54 mm) OD by 1.5-inch (38 mm) ID outer probe rods and 1-inch (25 mm) OD inner rods to provide access to the desired sampling interval either by use of a solid drive point or soil coring system (Figure 10, see also Technical Bulletin # 982100). To minimize compression of the formation and reduction of gas permeability, it is best to stop the DT21 system just above the interval where soil gas is to be sampled. The following steps (Figure 11) should be followed to install an implant for long-term soil gas monitoring:

- Once at the desired depth, the inner rod string and any soil sample is removed.
- A small thin-walled sample tube (P/N 19484) with drive head (P/N DT4055) is lowered through the outer rods and advanced ahead of the cutting shoe to remove a soil core where the implant will be installed (Figure 11). This sample tube (P/N 19484) is designed for low-density sands and finer-grained materials only.
- Once the soil core is removed a stiff brush (P/N BU600) may be lowered by extension rods (P/N AT671, etc.) into the open core hole in fine-grained or otherwise cohesive formations. The brush is rotated and moved up and down gently through the cored interval to relieve any smearing and reestablish natural gas flow into the void where the implant will be installed.
- The appropriate 6-inch (152 mm) or 12-inch (305 mm) long implant (Table 5) is attached to the selected tubing (Table 4) and lowered into the open core hole below the probe rods. Cap or cover the end of the tube at the surface to prevent clogging and/or loss of volatiles.
- Next, either environmental sand (P/N AT95) or fine glass beads (P/N AT93) are poured through the rod bore to fill the open hole around the implant screen. The probe rods should be retracted slowly to keep the filter media below the cutting shoe. Measure with suitable depth indicator to confirm the filter media extends at least 6 to 12 inches (152 to 305 mm) above the top of the implant.
- Grouting of the annulus may be accomplished in one of two ways.
 1. Fine bentonite chips (P/N AT91) are gravity poured through the rod bore as the rods are slowly retracted to keep chips below the cutting shoe. The chips are hydrated with water every 4- to 6-inch (102 to 152 mm) increment. Water should be added through a tube extending below the cutting shoe. This will prevent wetting the ID of the rods and possible bridging.
 2. A grout slurry of either bentonite powder (P/N AT92) or neat cement may be pumped by tremie tube using an appropriate grout machine to fill the bore hole as the drive rods are retracted.
- Once grouting is completed, suitable surface protection (P/N WP1771 or WP1741) should be installed to meet local needs and regulatory requirements. In remote locations such as landfills, a simple PVC pipe with slip-cap may provide suitable protection for short-term monitoring requirements.

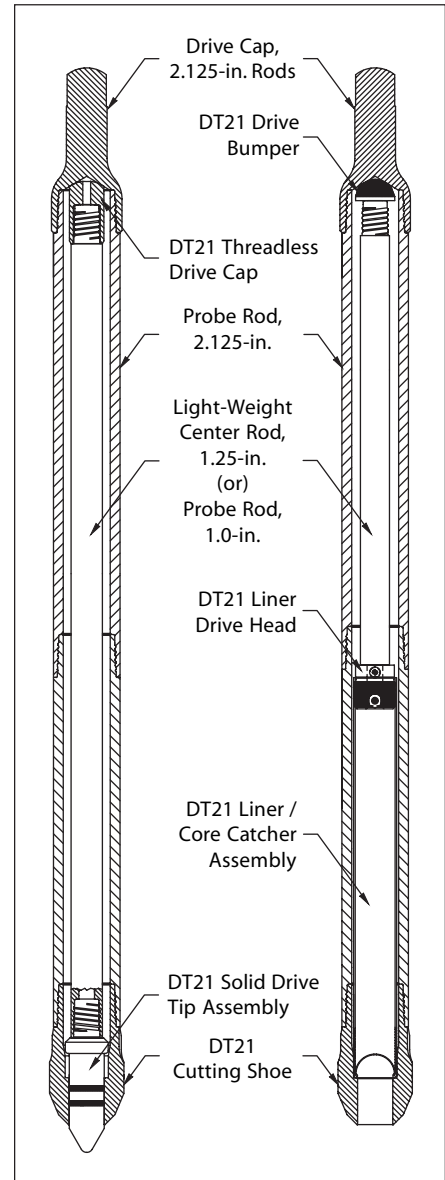
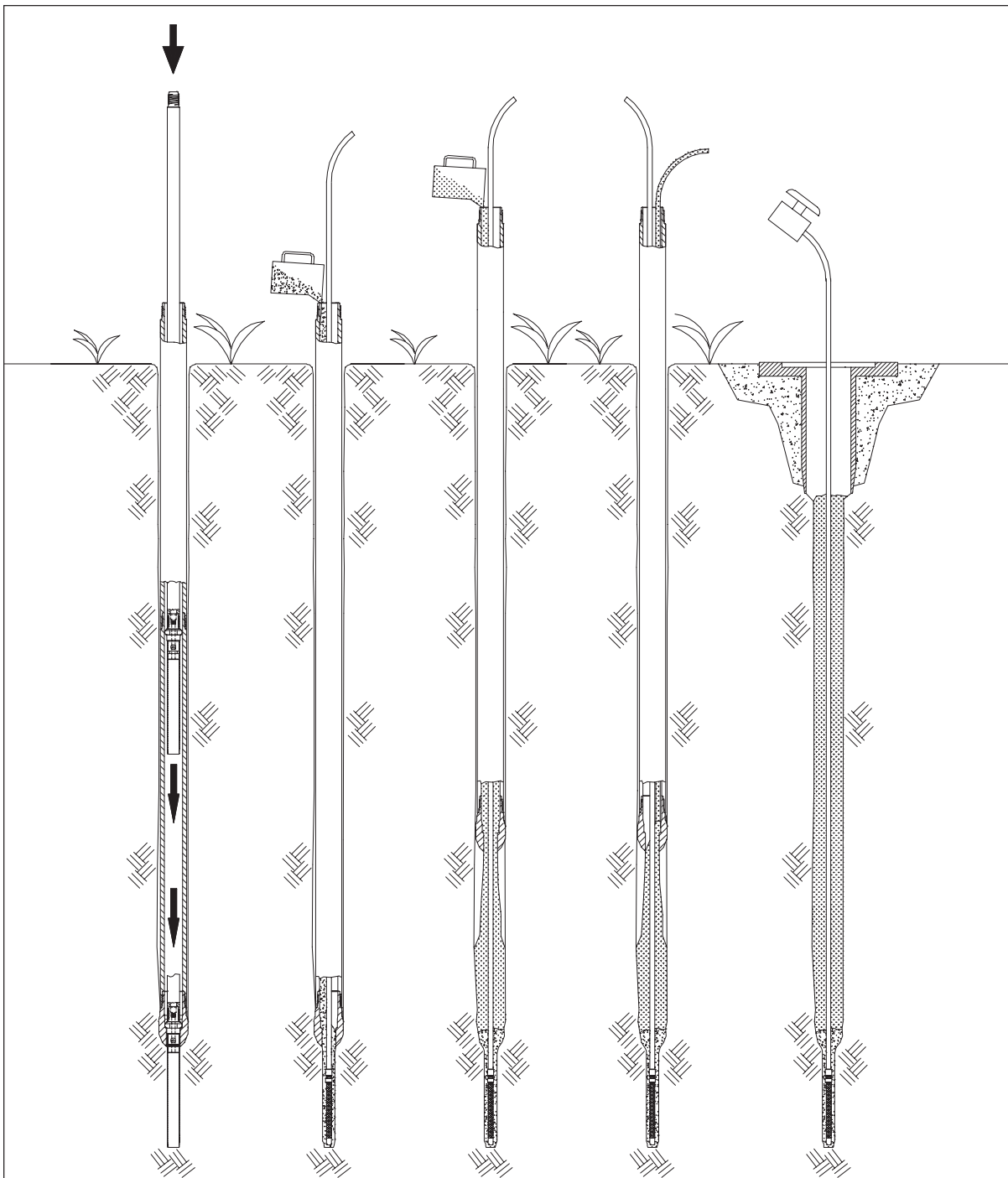

Figure 10: DT21 soil sampling tool string configurations.

The DT325 sampling system may also be used in a similar fashion to install high-integrity single-depth implants for soil gas sampling and long-term monitoring.



A. B. C1. C2. D.

- A. Advance the DT21 system to depth and remove the inner rod string. The pre-core assembly is attached to the lead inner rod and lowered through the outer rod bore. The thin-walled tube is advanced into the virgin soil ahead of the drive rods to remove a soil core.
- B. The soil gas implant is assembled and lowered into the open core hole with the tubing. Fine sand or glass beads are added through the rods slowly to prevent bridging.
- C1. Fine bentonite chips are added through the drive rods. A tube with funnel at the surface should be used to add water to hydrate the bentonite incrementally as the rods are retracted.
- C2. Alternatively, grout slurry may be pumped through a tremie tube to fill the probe hole as the rods are retracted. Use appropriate pump (GS1000 or GS500) and nylon tremie tube (P/N 11633).
- D. The sample tube is sealed with a suitable airtight cap or valve. Well protection is installed to meet local requirements

Figure 11: Installation of single-level implants for soil gas monitoring with the DT21 system.

7.2 Single-Depth, High-Integrity Soil Gas Wells

Under some conditions or to meet specific regulatory requirements, it may be necessary to install prepacked screen monitoring wells (Figure 12) for long-term soil gas monitoring. Smaller diameter wells (e.g. 0.5- or 0.75-inch ID) may be preferred for this option to minimize the amount of purging required before sampling is conducted. The DT21 system allows for this option and will provide high-integrity well construction with an excellent annular seal and well defined screened interval with filter media. This gas well installation process utilizes the same basic procedure as for the installation of prepacked screen wells for groundwater monitoring. See Geoprobe® Technical Bulletin No. 962000 for detailed discussion of this procedure or ASTM Standard Practice D6725. A different cap and seal mechanism will be required for the well to prevent venting of volatiles and permit for appropriate purging and sampling activities.

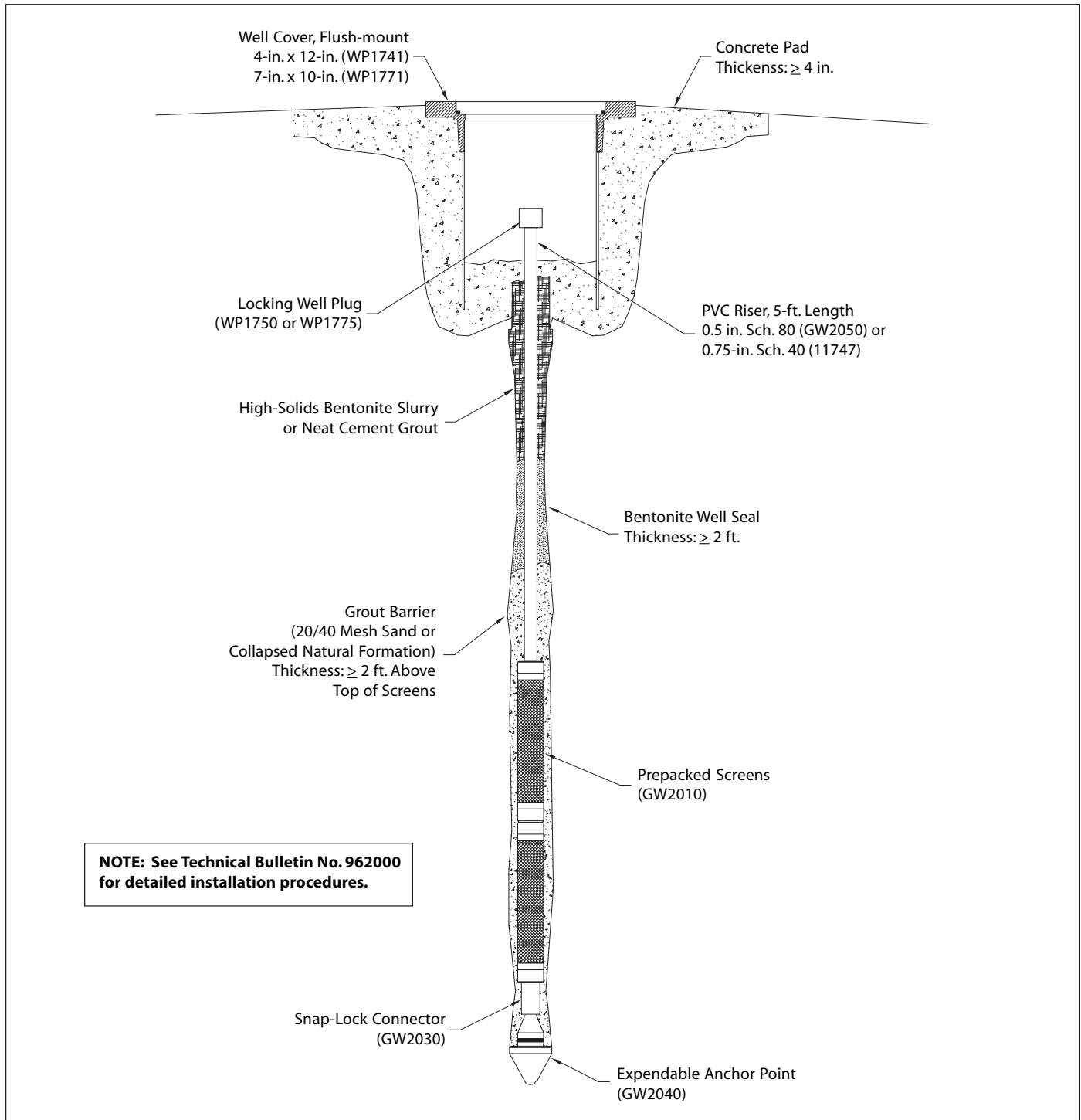

Figure 12: A properly installed Geoprobe® prepacked screen monitoring well.

7.3 Multiple-Depth High-Integrity Implants

Soil gas profiling with the DT325 system was discussed previously in Section 6.5 and Figure 9. As noted, this system may be used to install multilevel soil gas implants as the 3.25-inch diameter rods are retracted. It is recommended that DT325 soil sampling be conducted through the entire interval where soil gas implants are to be installed. Removal of the soil cores will minimize compression of the formation and loss of gas permeability where implants are to be installed. Once soil coring has been completed to the maximum desired depth, the multilevel soil gas implant installation is conducted as follows (refer to Figure 13):

- The inner rod string and last soil core is removed.
- A soil core may be removed below the cutting shoe as described above (Figure 11) for installation of the deepest gas implant, if desired.
- The selected implant (Table 5) and tubing (Table 4) are assembled and lowered to the bottom of the bore hole.
- Filter media is poured through the rod bore as the rods are slowly retracted until filter media extends at least 6 to 12 inches (152 to 305 mm) above the implant. Measure depth to top of filter media and keep below rods and cutting shoe to prevent bridging.
- Fine bentonite chips are poured through the rod bore as the rods are slowly retracted. Water is added through a tube to hydrate each 4- to 6-inch (102 to 152 mm) increment of bentonite. Avoid wetting the interior of the rods to prevent bridging of sand and bentonite that could result in damage or loss of implants. (Alternately, grout slurry could be pumped by tremie tube and grout pump to install the seal at each level. See Figure 11, Part C2.)
- Repeat the last three steps for each soil gas implant as the rods are retracted.
- Grout from top of the filter pack for the uppermost implant to about 1 foot (0.3 m) below grade.
- Install surface protection as required.

Vapor monitoring implants installed following this procedure will enable you to achieve stringent data quality objectives for collection of soil gas samples to be used in human health risk assessments for the vapor intrusion pathway (Cal RWQCB 1997, Cal. DTSC 2003, NYDOH 2005, U.S. EPA 2002, etc.).

Section 8.0

Direct Push Equipment Decontamination and Equipment Blanks

Without appropriate decontamination of downhole tooling and other sampling accessories there is significant opportunity for cross contamination and erroneous results. Various methods may be appropriate for equipment decontamination (decon) depending on the contaminant types and concentrations encountered (ASTM D 5088, Parker and Ranney, 2003). Most often downhole tools such as probe rods and point holders are cleaned with a soap-and-water wash and one or more clean water rinses. This may be most effective for VOCs if a heated pressure sprayer is used to conduct the decontamination. Measures for the control and containment of the spray and wastewater must be implemented. Appropriate health and safety protocols should be followed and adequate personal protective equipment should be worn. Refer to the project specific work plan and health and safety plan for guidance on appropriate safety protocols. Smaller parts may be washed and heated in an oven to drive off volatiles when appropriate.

When field analyses are conducted as sampling is performed in the field the analytical data can be used to guide decontamination requirements. Equipment used to collect samples that are nondetect will require less stringent decontamination measures than equipment used to collect samples from grossly contaminated areas. To assure that cross contamination is controlled equipment blanks should be collected on a regular basis (e.g. once a day or once every 10 samples, as appropriate to meet project DQOs). Equipment blanks should be collected from tool strings and sampling trains assembled just as they are for a typical sample location. The equipment blanks should be labeled and handled as other samples and submitted to the laboratory for the same analytical protocol.

NOTE: Soil coring through intervals where screens will be installed is necessary to minimize compaction and loss of gas permeability.

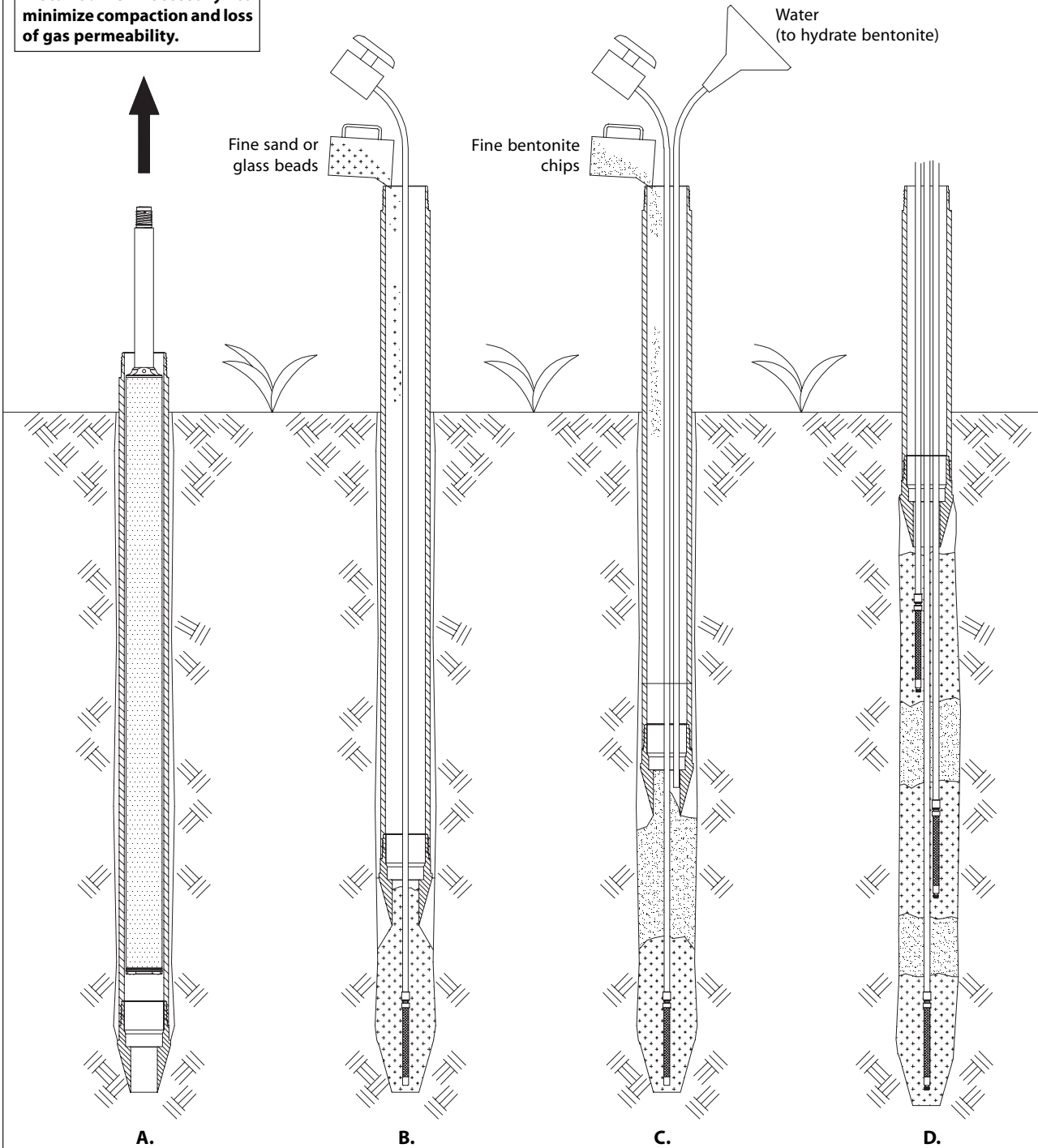

Figure 13: Use of the DT325 system to install multilevel soil gas implants.

Section 9.0 Abandonment and Grouting

To prevent migration of contaminants vertically along the probe hole to previously clean areas, proper abandonment and grouting techniques must be followed. For very shallow probe holes (e.g. < 5 ft (1.5 m)) in cohesive soils that remain open after the drive rods are removed, bentonite powder or fine bentonite chips may be added to the open hole incrementally and hydrated. In general, grout slurries should be pumped down the drive rods (Figure 14) or a tremie tube (Figure 11, Part C2) as the original drive rods are retracted from depths exceeding 5 feet (1.5 m). Pumps and accessories capable of injecting bentonite grout slurries or neat cement grout slurries through the small-diameter DP tools (Figure 15) will be required. Usually a 25% solids bentonite slurry is acceptable or a neat cement grout with 7 to 8 gallons (27 to 30 liters) of water per bag of cement may be required. Verify with state and local regulators the type and density of grout material necessary to meet local regulations. Proper abandonment and grouting is necessary to prevent substantial liability for contaminant migration if boreholes are left open.

Section 10.0 Techniques for Collection of Soil Gas Samples

10.1 DQOs Select the Technique

As discussed previously in Section 5.0, you must clearly define the DQOs before going to the field to collect soil gas samples. Samples that will be used for a human health risk assessment require much more stringent DQOs than samples that will simply be used to qualitatively determine if VOCs are present in the soil gas. A simple matrix (Table 2) will help you select the appropriate downhole tools paired with the correct sample collection methods to achieve the required sample quality. Remember, an expensive analysis does not make a poor quality sample better, it just wastes your money and time.

10.2 Sample Collection Flow Rate and Purge Volume

Another important consideration for sample collection is the actual flow rate at which the sample is purged from the ground. Some guidance documents indicate that the purge and sample flow rate for soil gas sample collection should not exceed 200 ml/min. (Cal RWQCB 1997, Cal. DTSC 2003, NYDOH 2005, U.S. EPA 2002, etc.). If very high flow rates or strong vacuum is applied, volatiles that were sorbed to solid phases or liquids in the pore space may be stripped out and enter the gas phase for sampling. Thus, the use of high flow rates or strong vacuum for soil gas sampling may result in a strong positive bias. This could cause an over estimation of the risk to human health and may result in expensive remedial actions being applied that are not necessary.

For most soil gas sampling activities it is common to purge at least one to three volumes from the sampling system before the sample is collected. For direct sampling methods this will simply be the volume inside the drive rods multiplied by three. For PRT methods this will essentially consist of the volume inside the tubing and the open cylinder in the ground created by retraction of the rods. The internal volume of common tubing sizes by foot or meter of length is provided in Table 4.

For permanent soil gas implants or wells, the volume of void space in the filter pack around the screen should be included in the calculation along with the open volume inside the screen and tubing to the surface. For a clean sand filter pack a porosity of 30% is usually considered representative. The following example of purge volume calculation may be useful.

(continued on Page 23)

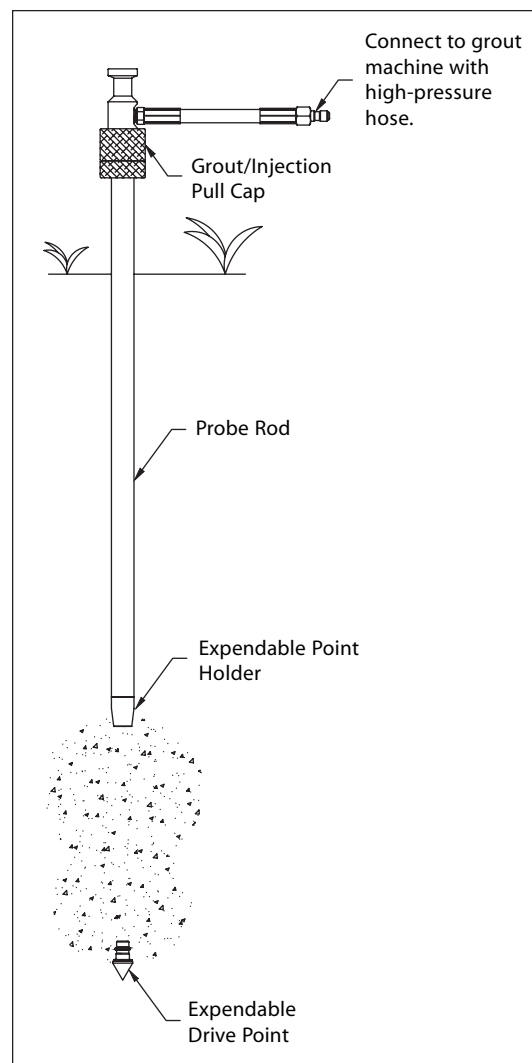

Figure 14: Grouting through tool string after soil gas sampling.

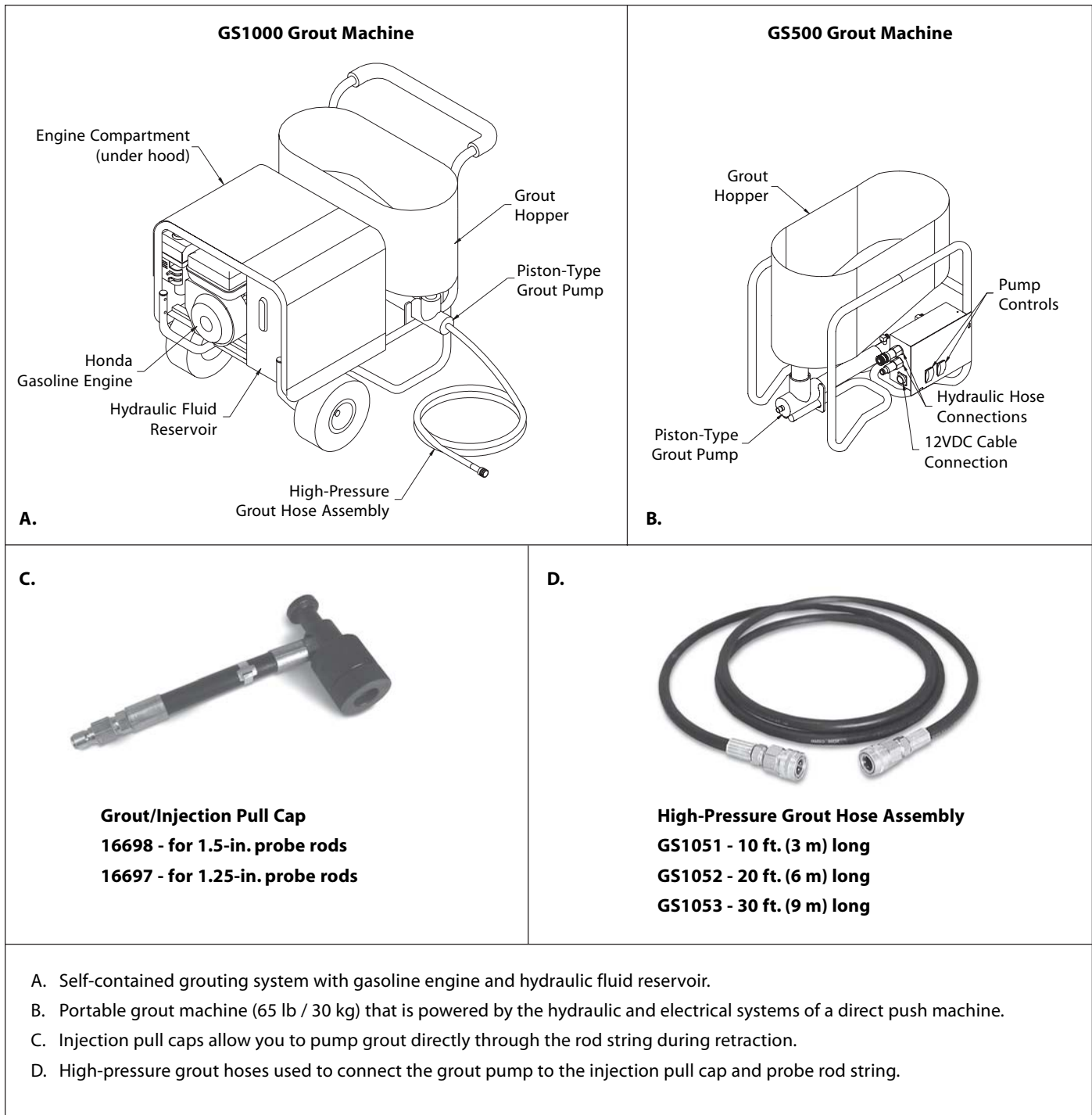

Figure 15: Typical grouting equipment for direct push soil gas operations.

Volume of a cylinder = $\pi \times \text{radius}^2 \times \text{height}$, where $\pi \sim 3.141$

For a 2.125-inch (5.4 cm) diameter borehole 24 inches (61 cm) long, the total volume in milliliters would be:

$$3.141 \times (2.7 \text{ cm})^2 \times 61 \text{ cm} = 1397 \text{ cc or approximately } 1400 \text{ ml}$$

For a 0.375-inch (0.95 cm) diameter implant 12 inches (30.5 cm) long, the volume would be:

$$3.141 \times (0.475)^2 \times 30.5 \text{ cm} = 21.6 \text{ cc or approximately } 22 \text{ ml}$$

Now subtract the implant volume from the total probe hole volume and then multiply the remainder by 0.30 to determine the 30% pore space in the filter media. This will be:

$$(1400 \text{ ml} - 22 \text{ ml}) \times 0.30 = 413.3 \text{ ml}$$

Add back in the total volume of the void in the implant and you have:

$$413.3 \text{ ml} + 22 \text{ ml} = 435.3 \text{ ml of void volume in the implant screen and filter media}$$

If you have 12 feet (3.7 m) of 0.25-inch (6.4 mm) ID tubing, the volume per foot from Table 4 is 9.7 ml. One purge volume will be:

$$435.3 \text{ ml} + (12 \text{ ft} \times 9.7 \text{ ml/ft}) = 551.7 \text{ ml}$$

and three purge volumes would be about 1650 ml. Purging at 200 ml/min, it would require approximately

$$1650 \text{ ml} / 200 \text{ ml/min} = 8.25 \text{ minutes}$$

to complete the three volume purge for this implant system before you would be ready to collect your sample. So you would want to estimate at least ten minutes for sample collection in your cost proposal when similar implants are to be sampled.

The purge volumes and time required to purge using the PRT sampling system with three different probe rod diameters, using a one-foot (30.5 cm) retraction/void is summarized below in Table 6.

Table 6: Purge volume and time with PRT system and selected rod diameters.

Rod Diameter, inches (cm)	1.0 (2.54)	1.25 (3.18)	1.5 (3.81)
Void Radius (r), inches (cm)	0.5 (1.27)	0.625 (1.59)	0.75 (1.91)
Void Length (L), inches (cm)	12 (30.5)	12 (30.5)	12 (30.5)
Single Void Volume (mL) ($\pi \times r^2 \times L$, where $\pi \sim 3.141$)	155	242	350
Tubing ID, inches (cm)	0.25 (0.64)	0.25 (0.64)	0.25 (0.64)
Tube Volume (mL/ft)	9.7	9.7	9.7
Tube Length (ft)	10	10	10
Total Tube Volume (mL)	97	97	97
Total System 1-volume (mL)	252	349	447
Approximate 3-System Volume (mL)	750	1050	1350
Required Purge Time at Flow Rate of 200 mL/min	3.75 min	5.25 min	6.75 min

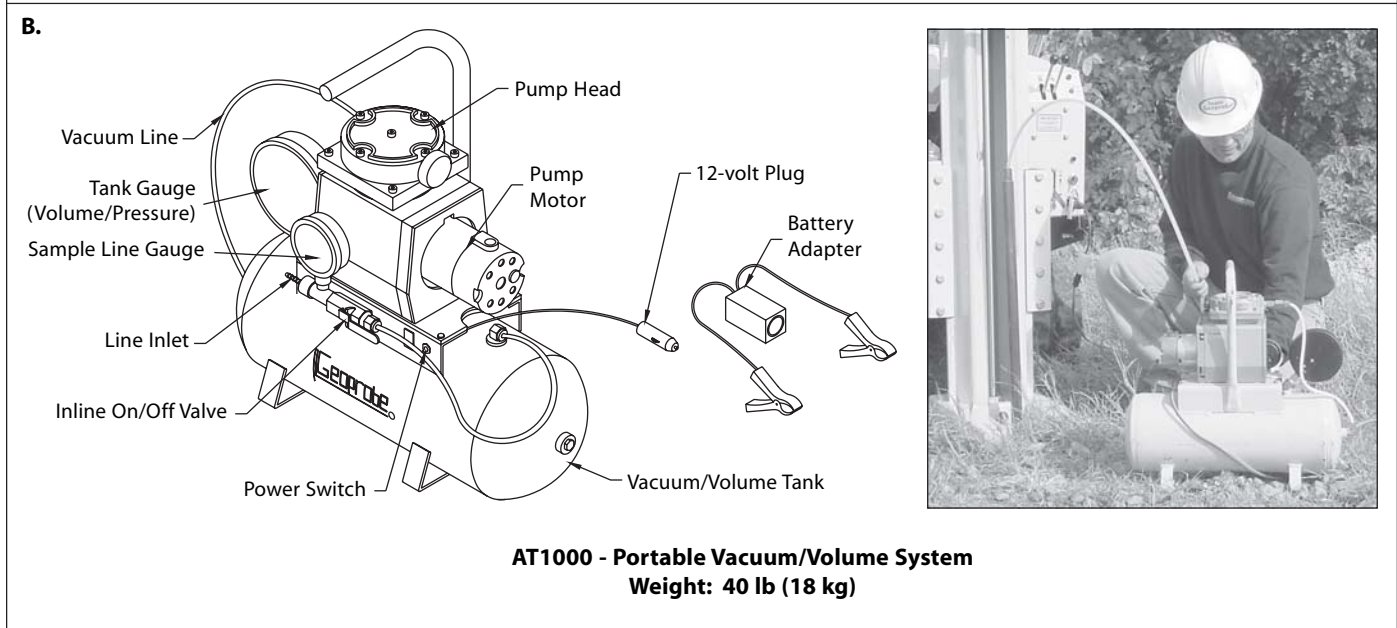
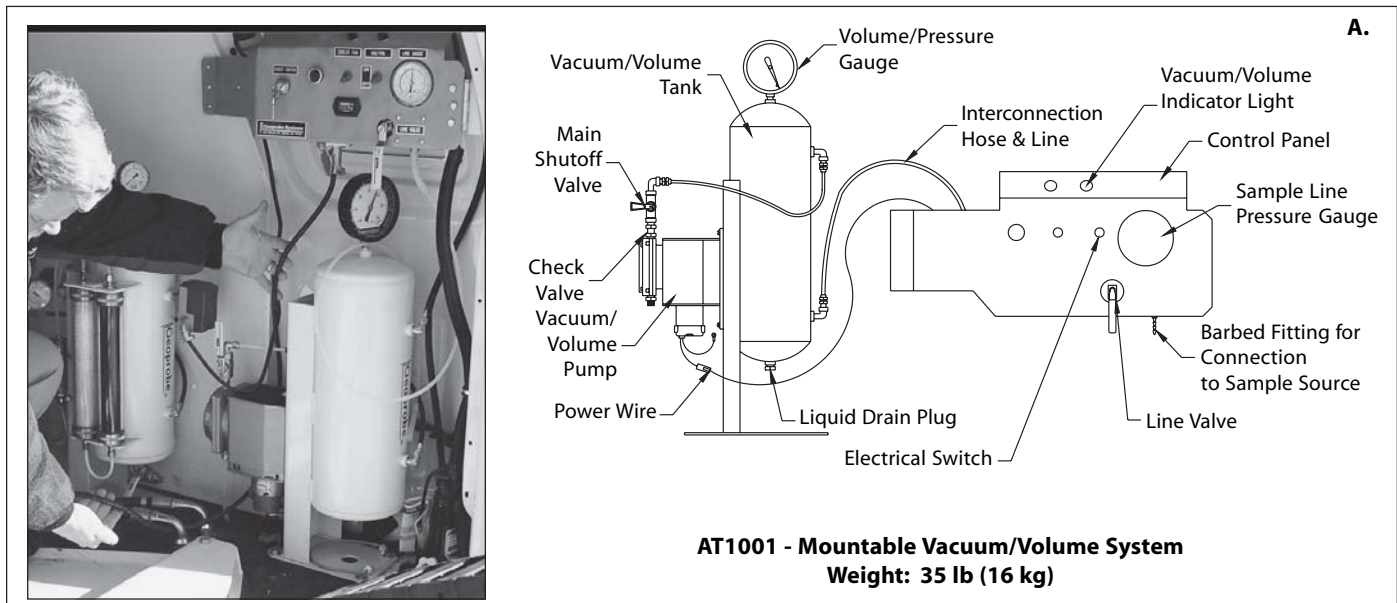

A. This system mounts in the back of a truck or van, often along with a Geoprobe® Model 5410 direct push machine.

B. The portable 12V system may be powered from the vehicle 12V accessory outlet (cigarette lighter) or clipped directly to the vehicle battery.

NOTE: Both systems include an 11-liter (2.9 gal.) tank and can provide up to 21 in. of Hg (70 centibars) of vacuum.

Figure 16: Vehicle-mounted and field-portable vacuum/volume systems for soil gas sampling.

10.3 The Vacuum/Volume System

The vacuum/volume (V/V) system (Figure 16) has been used to good advantage for soil gas sampling during soil gas surveys, especially when large purge and sample volumes (liters) are required. The V/V system allows the field operator to perform three basic functions that are essential to successful soil gas sampling. These are measurement of the:

- volume of gas extracted at a sample point
- initial vacuum applied to a sample point
- amount of time for a sampling point to return to atmospheric pressure after a vacuum has been applied for sampling

The field operator may wish to incorporate an adjustable needle valve at the sample line inlet to control the flow rate to the desired level. The portable V/V system may be useful for periodic sampling of permanent wells or implants for monitoring purposes. Detailed operation instructions for the V/V system are available (Geoprobe® 2003).

10.4 Syringe sampling & purging

During initial surveys and plume tracking efforts, a mobile lab with onboard gas chromatograph (GC) may be used to conduct field analysis. This can significantly reduce analytical costs and the need for multiple mobilizations to determine the extent of the contaminant plume. When a van-mounted Geoprobe® direct push machine is equipped with a GC it is convenient to collect the soil gas sample directly from the PRT sample line with the syringe that will be used to inject the gas sample on the GC column (Figure 17). A short section of silicone tubing is placed in-line to allow for insertion of the GC syringe and collection of the sample. The sample is then immediately injected in the onboard GC for analysis. This collection and field analysis technique is especially amenable to use of the Triad approach for site characterization (EPA 2003).

When smaller purge volumes are required, a large syringe may be used to purge the sample tube. Gas sampling syringes made of glass or plastics are available from scientific supply warehouses in sizes ranging from 50 ml volume to 250 ml volume. This may be a particularly useful approach when shallow sampling is done in areas that are difficult to access with larger tools and equipment. Usually a small on/off valve is fitted to the end of the sample tube and is closed as the syringe is removed to be emptied and reattached for additional purging. The field tech will have to manually control the purge and sample flow rate. After purging the syringe may be used to inject a sample into a Tedlar bag, or glass bulb for on-site analysis. If off-site analysis will be conducted, a small summa canister may be used to collect the sample.

10.5 Tedlar bags and glass sampling bulbs

These two sample collection options (Figure 18) have been widely used in soil gas surveys, especially when a mobile lab is stationed on-site to conduct the analyses as the samples are collected. These sample collection options also may be used when an off-site lab is to perform analyses but holding times for the samples may be limited. In addition, standard Tedlar bags and glass bulbs are transparent and exposure to sunlight is a concern. Some volatile organic contaminants may degrade when exposed to sunlight (especially ultraviolet light) so the sample containers must be stored out of the sunlight. A cooler or suitable box may be sufficient. Do not cool the samples if stored in a cooler as this may cause condensation and lead to biased sample results. Light-blocking Tedlar bags are available.

There are at least two ways to collect a sample in Tedlar bags. A large syringe may be used to extract the sample from the sample line and then it is injected into the Tedlar bag. Appropriate valves must be used on the syringe and bag to prevent ambient air contamination of the sample during transfer. Decontamination of the syringes between samples will be required to prevent cross contamination. An alternate method is to place the Tedlar bag inside a vacuum chamber with a port that allows connection to the sample line. A vacuum is applied outside the Tedlar bag and the bag expands and fills with gas from the sample line and downhole source. The downhole sample train must be purged before sample collection. Tedlar bags are generally considered a one-use disposable item, not to be decontaminated for reuse. Some regulatory agencies (Cal. EPA) discourage the use of Tedlar bags for soil gas sampling.



Figure 17: Syringe sampling for field analysis.

(continued on following page)

Alternatively, glass bulbs may be decontaminated for multiple reuse. However the glass bulbs are expensive and fragile, and decontamination requires additional equipment and man-hours. Blank analyses will also have to be performed periodically on the bulbs to verify no cross contamination occurs. The glass bulbs are usually placed in line during the purging process so they equilibrate with the gas being sampled. Smaller volume bulbs will require smaller system purge volumes and should still provide sufficient sample volume for duplicates and other QC measures if required. Decon may be accomplished by attaching the open bulbs to a vacuum pump and purging the bulbs while they are being heated in a small oven in the mobile lab on-site. A tubing manifold can connect several bulbs to one vacuum pump.

10.6 Summa Canisters

For evaluation of the vapor intrusion pathway and human health risk assessments, summa canisters (Figure 19) are preferred for sample collection and transport to a fixed lab facility for analysis. These stainless steel devices are usually supplied by the lab clean and ready for sample collection. The canisters are under vacuum and are simply attached to the sample line for collection of the soil gas. (The three-volume pre-sampling purge is conducted before the summa canister is attached to the sampling train.)

A vacuum gauge and valve should be included on the canister inlet. The gauge will indicate when the canister is full and the valve can be used to control the sample flow rate from the downhole source at the 200 ml/min rate to prevent stripping of volatiles and biased sample results. Flow control valves may be set by the supplier at the requested flow rate. Smaller summa canisters (500 ml) may be preferable to minimize the sample collection time at the 200 ml/min flow rate.

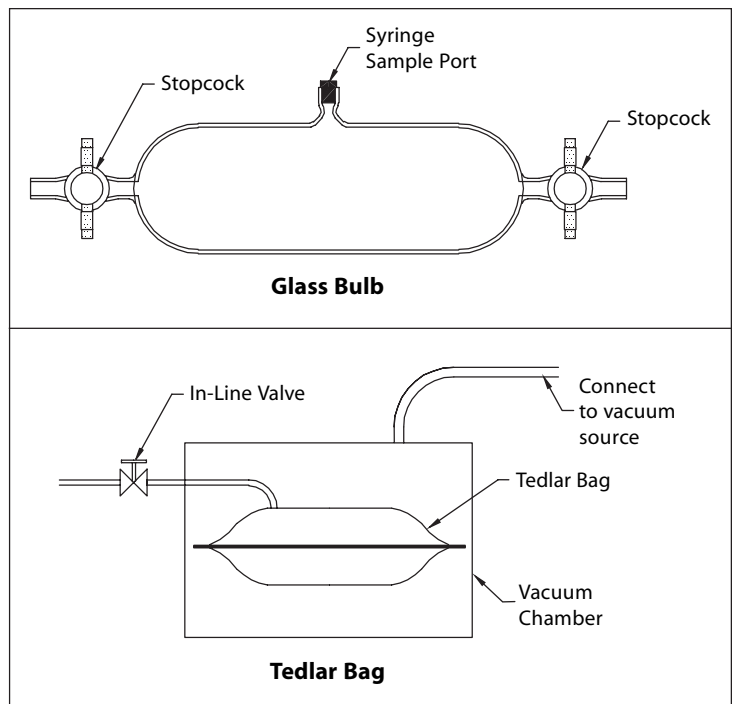

Figure 18: Tedlar bag and glass bulb for soil gas sampling.

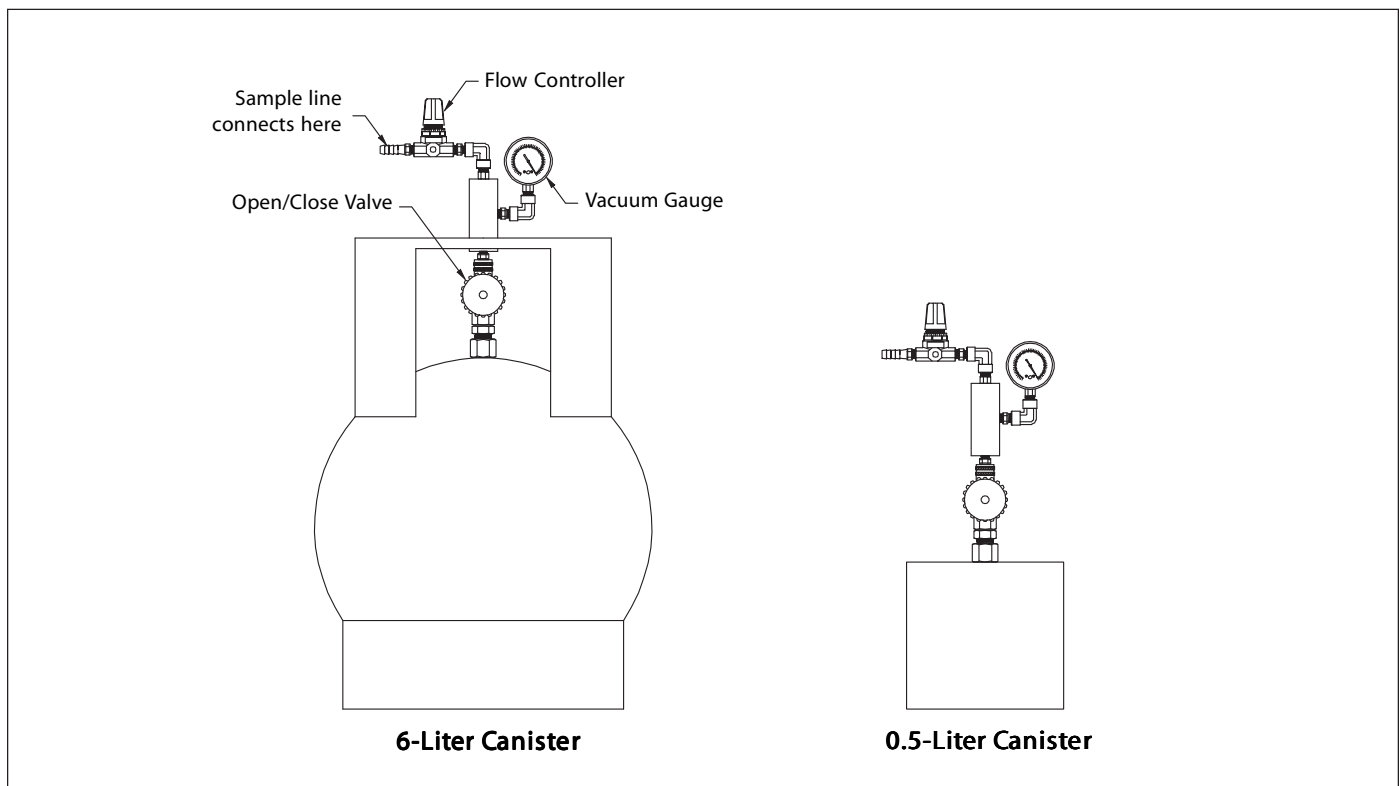

Figure 19: Summa canisters used for collection, storage, and transport of high-quality soil gas samples.

Section 11.0 System Leak Tests for Field QC

Leak testing is a critical step to perform in the field to assure that system leaks do not degrade sample quality and cause biased results. There are at least three categories of leak testing that should be considered. These are:

- Integrity of vacuum source
- Integrity of the sampling train
- Integrity of downhole tool system

The vacuum source may be as simple as a large syringe or as complex as a vacuum/volume system (see Figure 16). To verify that the vacuum supply itself does not have leaks, it should be tested periodically (e.g. once a day or every 10 samples). To test the integrity of your vacuum system the inlet valve should be closed or the inlet line should be plugged appropriately. The vacuum source is activated (syringe plunger retracted/vacuum pump turned on) and vacuum is applied. An in-line vacuum gauge should be included to quantitatively monitor loss of vacuum over time. Once the vacuum is applied, the system is “shut-in” so that loss of vacuum over time may be observed. For more complex systems the leak test may need to last 30 minutes to check for smaller leaks. Corrective action should be taken if leaks are detected.

Most often system leaks occur at aboveground plumbing connections where the sampling device is connected in-line between the vacuum supply and the sample line from the subsurface (sampling train). Probably the easiest and most effective way to determine if there are leaks during the sampling process is to apply a volatile compound around the fittings and analyze for that compound at the lab. One of the simplest and most effective ways to accomplish this is to wet paper towels with isopropyl alcohol and wrap them around the fittings and connections in the sampling train. Isopropyl alcohol may be purchased at the local pharmacy or department store. Remember, this material (liquid and vapor) is flammable and should be stored and handled appropriately.

Some downhole grab sampling systems can be tested for leaks before sampling is conducted. This may be accomplished for the direct sampling system (Figure 4) and the PRT sampling system (Figure 5). Expendable points with O-rings must be used so that an effective leak test can be accomplished. [Note: Neither monitoring nor grab sampling systems with downhole screens can be leak tested in this manner.] For the direct sampling system, the gas sampling cap with O-ring is installed on the drive rods and the tubing is connected between the cap and vacuum supply. Before the rods are retracted from the expendable point, a vacuum is applied to the sampling train and downhole system. The system is shut-in and the in-line vacuum gauge is observed for a period of time to determine if leaks are present.

For the PRT system, the PRT adapter (with fresh O-ring) is installed on the selected tubing. The adapter and tubing are lowered through the drive rods and the adapter is threaded into place. Before the drive rods are retracted off of the expendable point, vacuum is applied to the sampling train. The in-line vacuum gauge is observed to determine if leaks are present. Once the integrity of the sampling system is confirmed, the drive rods are retracted and soil gas purging and sampling is conducted.

A note of caution: System leak tests as described above will not allow you to determine if ambient air or soil gas from overlying zones is migrating into the interval being sampled. In order to prevent this problem, be sure that the expendable point and point holder are no larger in diameter than the outside diameter of the drive rods used in the tool string. Additionally, bentonite powder may be poured around the tool string at the ground surface and hydrated to help prevent ambient air intrusion during the sampling process.

Section 12.0

Mapping Soil Gas Plumes

During the initial stages of a soil gas or VIP investigation it is wise to construct site maps that plot the location of each soil gas sample collection point. Then once the sample analyses are completed, the results may be plotted on the map and contours drawn to define the probable extent of the plume and areas of differing concentration (Figures 20 and 21). In many situations this will help locate sources for the contaminant plumes and define the general direction of contaminant migration. Often, soil gas plumes will develop over groundwater contaminant plumes and roughly mimic the extent of contamination in the local groundwater. In many urban and suburban areas there may be multiple plumes of different contaminants originating from different sources. Sometimes the source area(s) may be located outside the initial boundaries set for the investigation.

Use of on-site analysis with a mobile laboratory will optimize the investigation and plume definition. When field analyses are plotted on site maps daily as results are obtained, the field team can determine if new sample locations should be added to better define the plume. Just as important, nondetect samples can indicate that additional sampling locations planned for some areas may be deleted to minimize cost and time requirements. Application of the Triad Approach (EPA 2003) can be used to obtain the data needed while minimizing costs and multiple mobilizations to the field.

Section 13.0

Health & Safety Considerations

All personnel working on an investigation where hazardous contaminants may be present must be OSHA 40 hour health and safety trained as required by 29 CFR 1910.120. The following discussion is provided as a brief overview of some of the health and safety issues that may be encountered during soil gas investigations. The field team should have a written health and safety plan that adequately addresses the possible physical and chemical exposure hazards that may be encountered during the investigation. Daily meetings to review health and safety conditions and any changes in the work environment should be conducted with the field team.

There are many types of health and safety issues to be considered during a soil gas investigation, or at any site where potentially hazardous contaminants may be present. These include physical hazards as well as potential exposure hazards to contaminants under investigation. Some of the physical hazards are associated with the use and operation of tools, equipment, and Geoprobe® direct push machines in the field. Basic precautions should be followed to prevent injury when operating tools and equipment such as wearing hard hats, steel-toe boots, appropriate gloves, eye protection, and hearing protection as necessary. Watch for pinch points on hydraulic equipment, machinery, and tools. Be familiar with the safety features of equipment being operated in the field, such as kill switches. Whenever subsurface sampling is to be conducted, all subsurface utilities must be professionally located and clearly marked to prevent accidents. Overhead utilities, especially high-voltage electrical lines, should be avoided. Adequate spacing between high-voltage lines and equipment masts or derricks should be maintained, check local requirements. When working in areas where vehicular traffic is a concern, wear appropriate high visibility clothing and use traffic cones to mark the work area.

The potential for exposure to hazardous contaminants is a reality whenever subsurface environmental investigations are conducted. The use of appropriate ambient air monitoring equipment is a must. Wearing appropriate clothing (e.g. tyvek, saranex, nitrile gloves) and air purification equipment (e.g. air purifying respirators (APR) or self contained breathing apparatus (SCBA)) for personal protection should be a routinely planned for and donned when necessary. The field team should have a written health and safety plan that reviews all these concerns and more that provides for appropriate measures when ambient air concentrations of contaminants exceeds the predetermined safety levels.

Section 14.0

Summary

There are several tools and methods available to obtain soil gas samples with direct push techniques. Single tube methods are generally more time efficient and are often used during surveys to define the extent of the plume and help with location of source areas. These methods primarily provide sampling at a single-depth with each advance of the tool string. Conversely, dual tube methods are generally a little more time consuming but allow the operator the option to conduct soil gas profiling at multiple depths during one advancement of the tool string. The dual tube systems also allow the investigator to install high-integrity soil gas implants or monitoring wells. The placement of filter media in the screened interval and annular seals by the dual tube methods allows the sampler to achieve sample quality levels to meet the needs of human health risk assessments for the vapor intrusion pathway. Selection of the appropriate sample collection device and procedure is an integral part of achieving the required DQOs. While on-site analysis with a well-equipped mobile laboratory can expedite completion of the field work and plume definition, off-site analytical work may be required under some conditions to meet the more stringent requirements of human health risk assessment for the vapor intrusion pathway.

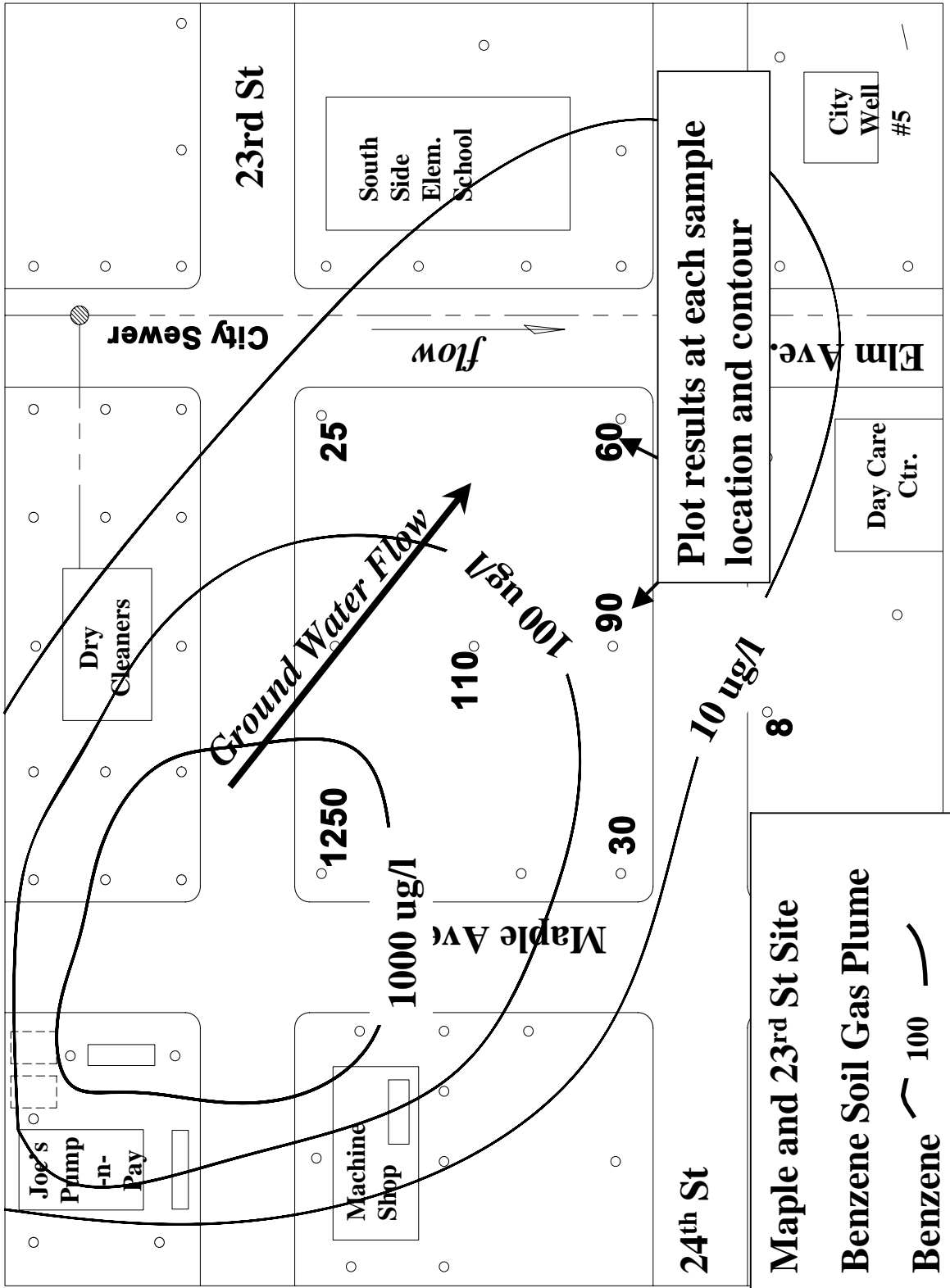

Figure 20: Mapping benzene plume for soil gas investigation.

References

- American Society of Testing and Materials (ASTM) 2004. D5088 Standard Practice for Decontamination of Field Equipment Used at Waste Sites. In Annual Book of ASTM Standards Vol. 04.08. ASTM West Conshohocken, PA. www.astm.org.
- ASTM 2004. D5314 Standard Guide for Soil Gas Monitoring in the Vadose Zone. In Annual Book of ASTM Standards Vol. 04.08. ASTM West Conshohocken, PA. www.astm.org.
- ASTM 2005. D6001 Standard Guide for Direct-Push Water Sampling for Geoenvironmental Investigations. In Annual Book of ASTM Standards Vol. 04.09. ASTM West Conshohocken, PA. www.astm.org.
- ASTM 2005. D6282 Standard Guide for Direct Push Soil Sampling for Environmental Site Characterizations. In Annual Book of ASTM Standards Vol. 04.09. ASTM West Conshohocken, PA. www.astm.org.
- ASTM 2005. D6725 Standard Practice for Direct Push Installation of Prepacked Screen Monitoring Wells in Unconsolidated Aquifers. In Annual Book of ASTM Standards Vol. 04.09. ASTM West Conshohocken, PA. www.astm.org.
- ASTM 2006. D7242 Standard Practice for Field Pneumatic Slug (Instantaneous Change in Head) Tests to Determine Hydraulic Properties of Aquifers with Direct Push Ground Water Samplers. ASTM West Conshohocken, PA. www.astm.org.
- CRC Press, 1975. CRC Handbook of Chemistry and Physics, 76th Edition. David R. Lide, Ph.D., Editor in Chief. CRC Press, New York.
- Geoprobe Systems®, 2001. Manual Slide Hammer, Operation Instructions. Technical Bulletin No. 17743. Kejr Inc., Salina, KS.
- Geoprobe Systems®, 2002. Geoprobe® 0.5-in. x 1.4-in. OD and 0.75-in. x 1.4-in. OD Prepacked Screen Monitoring Wells, Standard Operating Procedure. Technical Bulletin No. 962000. Kejr Inc., Salina, KS.
- Geoprobe Systems®, 2003. Geoprobe® DT21 Dual Tube Soil Sampling System, Standard Operating Procedure. Technical Bulletin No. 982100. Kejr Inc., Salina, KS.
- Geoprobe Systems®, 2003. Geoprobe Systems® Tools Catalog, V. 6. Kejr, Inc., Salina, KS. www.geoprobe.com
- McCall, Wesley, David M. Nielsen, Stephen P Rarrington, and Thomas M. Christy, 2006. Use of Direct Push Technologies in Environmental Site Characterization and Ground-Water Monitoring. In *Practical Handbook of Environmental Site Characterization and Ground-Water Monitoring*, David M. Nielsen, Ed. CRC Press, Boca Raton, Florida. Pages 345 – 471.
- California Regional Water Quality Control Board, Los Angeles Region, 1997. Interim Guidance for Active Soil Gas Investigation. February. www.waterboards.ca.gov/losangeles.
- California Department of Toxic Substances Control and Los Angeles Regional Water Quality Control Board, 2003. Advisory – Active Soil Gas Investigations. January. www.waterboards.ca.gov/losangeles.
- New York State Department of Health (NY DOH), 2005. Guidance for Evaluating Soil Vapor Intrusion in the State of New York: Public Comment Draft. Center for Environmental Health, Bureau of Environmental Exposure Investigation. Troy, New York. www.dec.state.ny.us/website/der/guidance/vapor.
- National Institute for Occupational Safety and Health (NIOSH), 1990. Pocket Guide to Chemical Hazards. U.S. Dept. of Health and Human Services. Washington, D.C. June.
- Parker, Louise V. and Thomas A. Ranney, 2003. An Environmental Friendly Decontamination Protocol for Ground Water Sampling Devices. *Ground Water Monitoring & Remediation*, Vol. 23, no. 2. March. Pages 84-91.
- U.S. EPA, 1986. Test Methods for Evaluating Solid Waste, Laboratory Manual, Third Ed. OSWER, Washington, D.C. SW-846. November.
- U.S. EPA 1997. Expedited Site Assessment Tools for Underground Storage Tank Sites: A Guide for Regulators. Office of Underground Storage Tanks, OSWER. OSWER 5403G: EPA 510-B-97-001. March.
- U.S. Environmental Protection Agency, 2002. OSWER Draft Guidance for Evaluating the Vapor Intrusion to Indoor Air Pathway from Groundwater and Soils (Subsurface Vapor Intrusion Guidance). Federal Register Notice – November 29, 2002. www.epa.gov/epaoswer/hazwaste/ca/eis/vapor.htm.
- U.S. EPA 2003. Using the Triad Approach to Streamline Brownfields Site Assessment and Cleanup. EPA 542-B-03-002. June. www.epa.gov/tio.

Geoprobe®, Geoprobe Systems®, Macro-Core®, and Direct Image®
are Registered Trademarks of Kejr, Inc., Salina, Kansas

© 2006 Kejr, Inc.
ALL RIGHTS RESERVED.

No part of this publication may be reproduced or transmitted in any form or by any means, electronic or mechanical, including photocopy, recording, or any information storage and retrieval system, without written permission from Kejr, Inc.



601 N. Broadway • Salina, KS 67401

1-800-436-7762 • Fax 785-825-2097

www.geoprobe.com