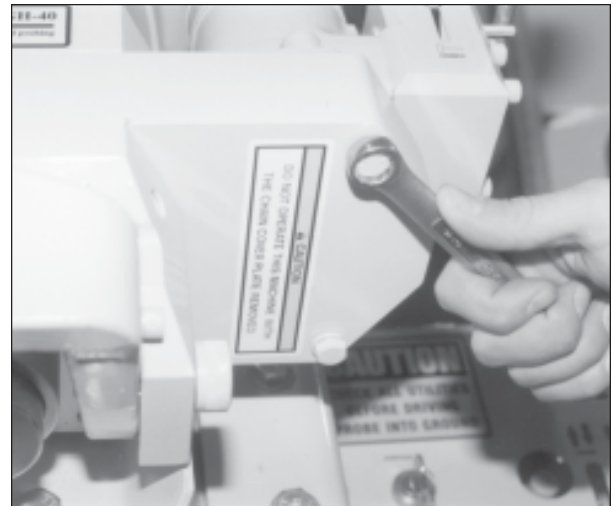
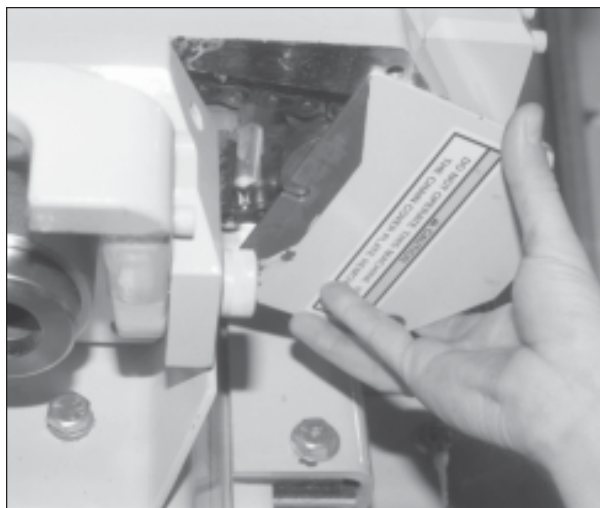




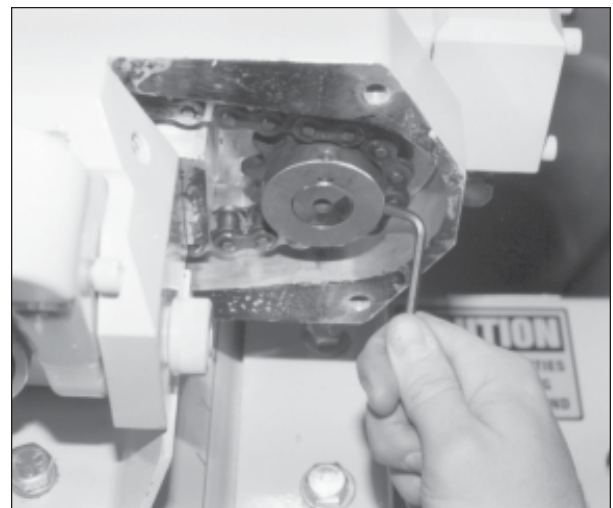
**Fig. 17.1. Remove hammer member.**



**Fig. 17.2. Remove chain cover plate bolts.**



**Fig. 17.3. Remove chain cover plate.**



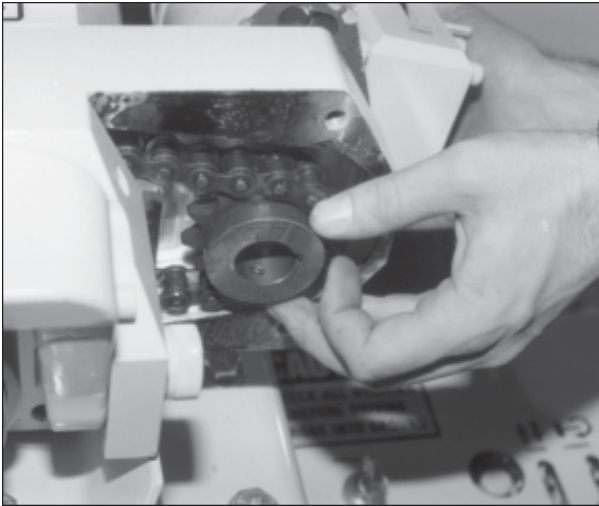
**Fig. 17.4. Loosen set screws at base of 12-tooth sprocket.**



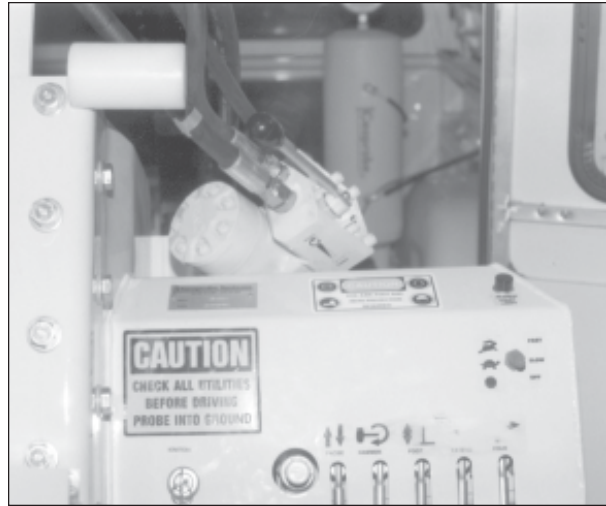
**Fig. 17.5. Remove socket head cap screws from hydraulic motor mounting holes.**



**Fig. 17.6. Lift hydraulic motor off gear drive box.**



**Fig. 17.7. Remove 12-tooth sprocket from hydraulic motor shaft.**



**Fig. 17.8. Rest hydraulic motor on control panel.**



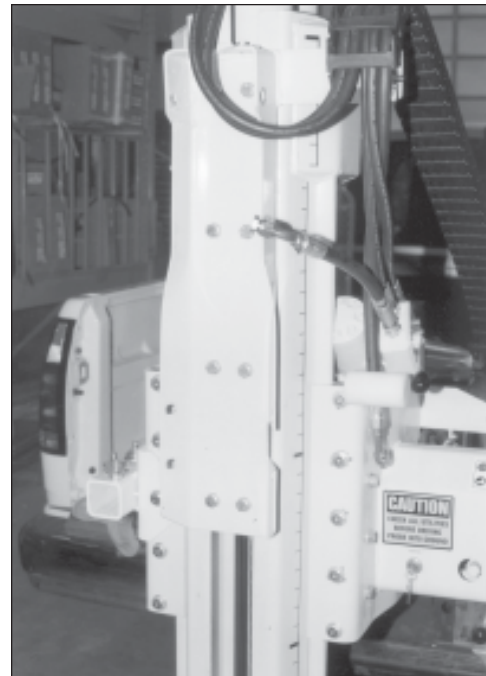
**Fig. 17.9A. Remove lower mounting bolts.**



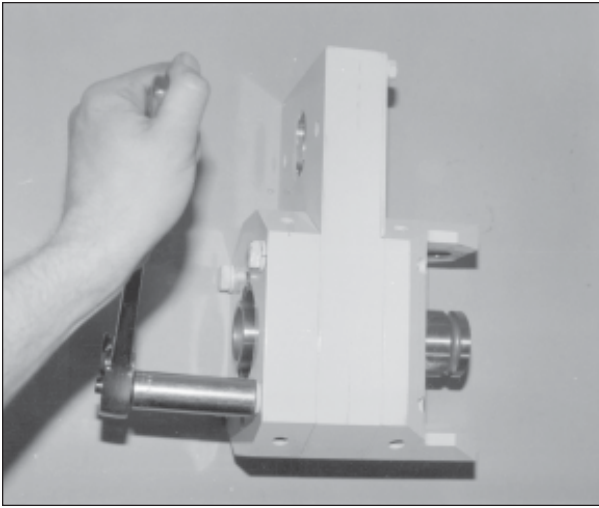
**Fig. 17.9B. Remove lower mounting bolts.**



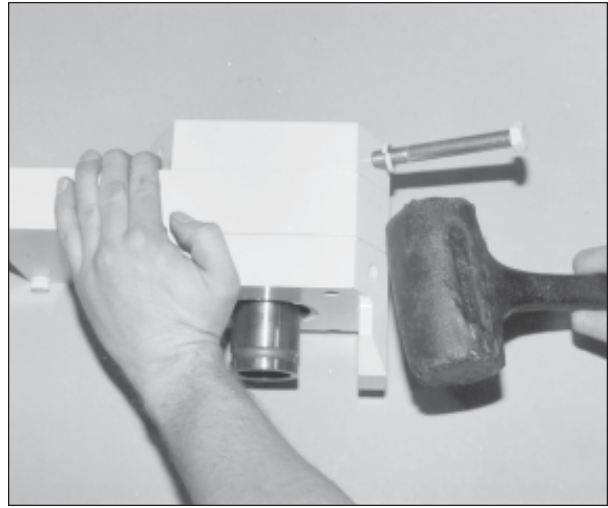
**Fig. 17.10A. Lift rotation member out of hammer cradle.**



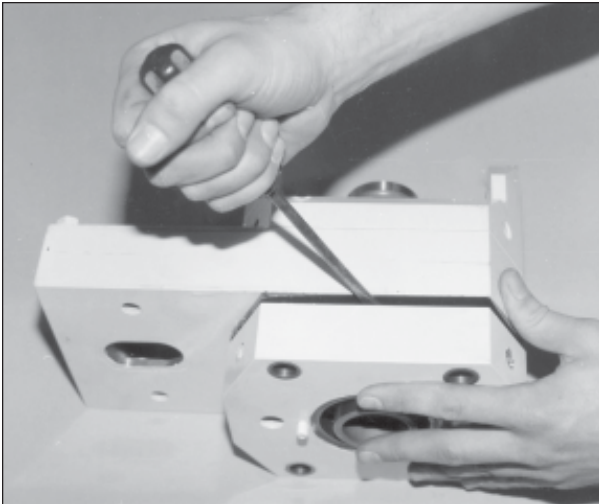
**Fig. 17.10B. Hammer member, rotation member, and hydraulic motor removed from hammer cradle.**



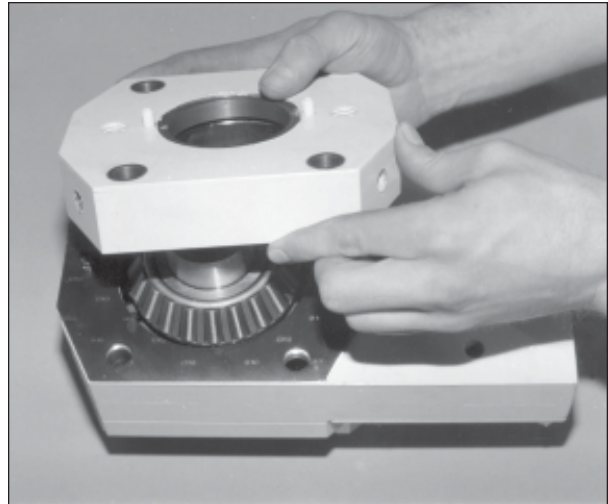
**Fig. 17.11. Remove bolts and lock washers from top plate.**



**Fig. 17.12. Gently tap bolts to separate plates from gear drive box.**



**Fig. 17.13. If necessary, pry top plate away from gear drive box with screwdriver.**

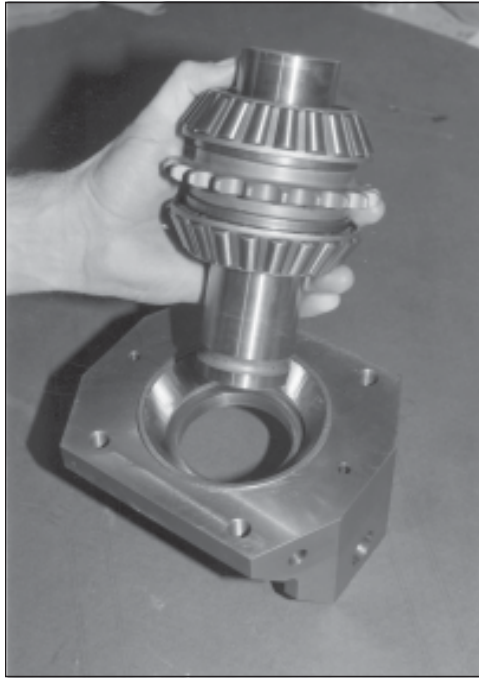


**Fig. 17.14. Remove top plate from gear drive box.**

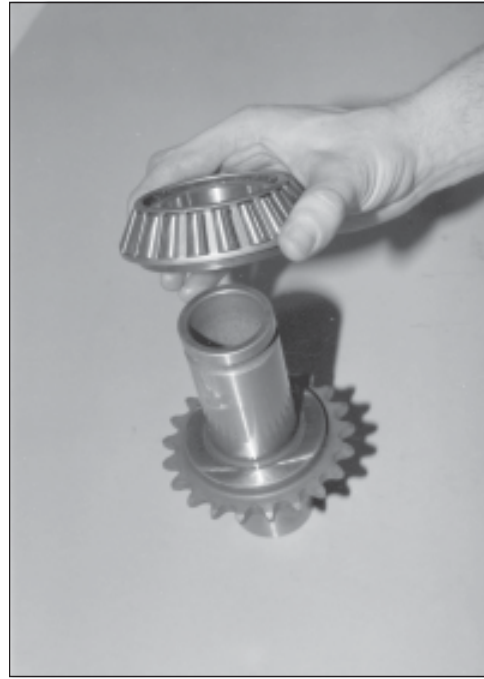


**Fig. 17.15. Lift gear drive box off bottom plate.**

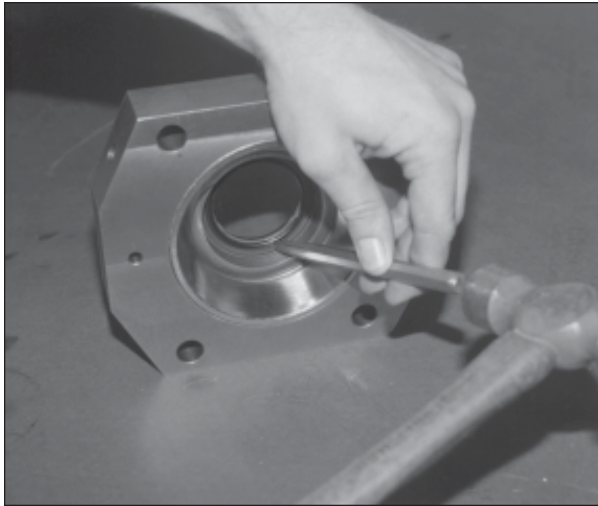




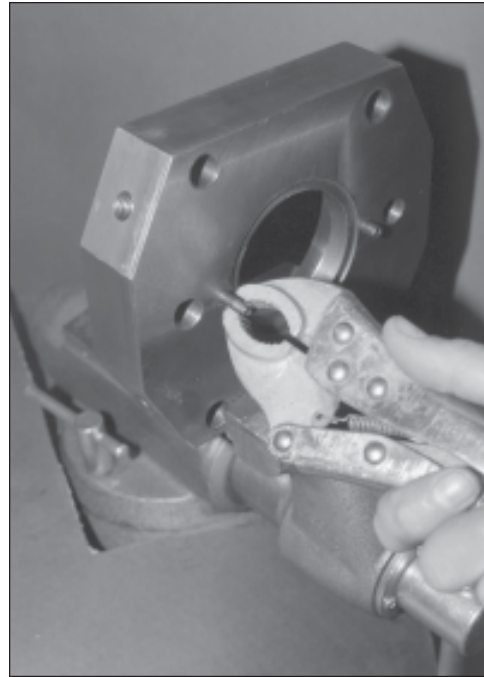
**Fig. 17.16. Pull hex drive gear out of bottom plate.**



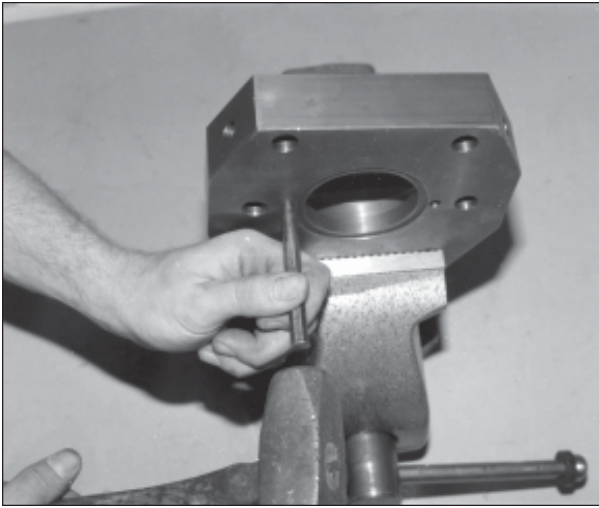
**Fig. 17.17. Remove bearings from hex drive.**



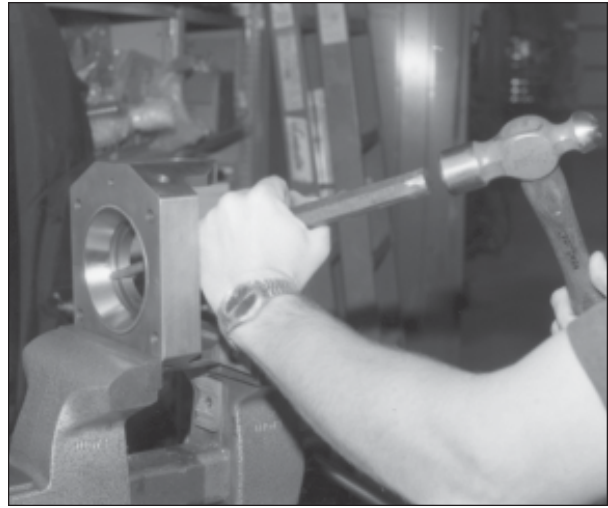
**Fig. 17.18. Remove top and bottom grease seals from top and bottom plates.**



**Fig. 17.19. Remove hammer alignment pins from top plate.**



**Fig. 17.20.** Use a dowel pin or punch to remove bearing race from top plate.



**Fig. 17.21.** Use a chisel to remove bearing race from bottom plate.

## 18.0 HEX DRIVE GEAR, BEARINGS, AND SEALS INSTALLATION

**NOTE:** Nearly all internal parts in this section are pictured free of grease. Normally, the tapered roller bearings mentioned in this section would be packed with wheel bearing grease prior to assembly.

**18.1** Prior to assembly, all parts should be thoroughly cleaned with solvent and dried with compressed air.

**IMPORTANT:** Wear safety glasses during all hammering procedures.

**18.2** Place bottom plate on a clean, solid surface, preferably on an anvil or piece of flat steel. Install bearing race into the bottom plate with a brass hammer or hammer and brass dowel (Fig. 18.1). Work around the race in a criss-cross pattern, hammering the race into place in small increments.

**18.3** Fully seat the race against the shoulder in the bottom plate (Fig. 18.2). A complete seat is indicated by a ringing sound. Visually, the top of the tapered edge of the race will stop just short of being flush with the mating surface of the plate.

**18.4** Install a bearing race in the top plate in the same manner as the bottom plate.

**18.5** Pack both tapered roller bearings, either by hand or with a wheel bearing packer, with wheel bearing grease (Fig. 18.3). Make sure the bearings are thoroughly packed. Excess grease, however, on the inside and outside of the bearing is not desirable as it will leak out of the hex gear drive during operation.

**18.6** Lay one bearing in the race installed in the bottom plate (Fig. 18.4).

**18.7** Make sure that both the hex drive gear (Fig. 18.5A) and the inner race surfaces where the hex drive gear mates with the inner bearing race (Fig. 18.5B) are free of grease. This is critical to the maintenance of proper clearances during assembly.

**18.8** You've had to read through a lot of instructions to get this far. This would probably be a good time for a cup of coffee or a soda. Pull up a chair (no photo required) and take a rest!

**18.9** Slide the long stem of the hex drive gear through the bottom bearing (Fig. 18.6A) until it seats completely. There should be no clearance between shoulder of hex drive gear and the inner bearing race (Fig. 18.6B).

**18.10** Install the two gear box alignment pins in the aluminum gear drive box with a brass hammer if they were removed or fell out during disassembly (Fig. 18.7). The pins should protrude an equal distance, approximately 5/16" from each side of the drive gear box.

**18.11** Position the bottom plate so that the detent ball in the latch, or its indenture in the bottom plate, is on the left side of the plate nearest to and facing the technician (Fig. 18.8). If the hammer latch was not removed, the hammer latch slot will face downward toward the workbench.

**18.12** Mating surfaces of the bottom plate (Fig. 18.9A) and the drive gear box should be free of grease (Fig. 18.9B).

**18.13** Prior to installing the next bearing, ensure that no grease is on either the inner bearing race mating surface (Fig. 18.10A) or the hex drive mating surface (Fig. 18.10B). Make sure that the mating surfaces on the top plate (Fig. 18.10C) and the gear drive box are free of grease (Fig. 18.10D).

**18.14** Install the second tapered roller bearing on the hex drive gear (Fig. 18.11). The bearing taper should face up and the bearing inner-race should seat completely against the shoulder of the hex drive gear.

- 18.15** Place a new gear box shim on the bottom plate so that the bolt holes align correctly (Fig. 18.12). Shims are available in .005, .010, and .020 thicknesses. Replacement shims should be of the same thickness as those removed during disassembly.
- 18.16** Lower the gear drive box onto the bottom plate and shim with the chain cover plate portion of the gear drive box to the right (Fig. 18.13). Make sure the shim seats correctly and does not wrinkle. Double check bolt hole alignment as the gear drive box is lowered onto the bottom plate.
- 18.17** Place original shim or one of the same thickness on the top of the gear drive box (Fig. 18.14).
- 18.18** Before the top plate is installed on the gear drive box, make sure that the bolt holes line up properly.
- 18.19** Align the bolt holes and install the top plate on the gear drive box (Fig. 18.15).
- 18.20** Secure bottom plate, gear drive box, and top plate with the four original bolts and lock washers (Fig. 18.16). Evenly and securely tighten bolts in a crisscross pattern with a 3/4" socket and 1/2" drive socket wrench.
- 18.21** Check hex drive gear for proper rotation. Hex drive gear should rotate by hand. If it does not, install a drill steel. If the drill steel will turn by hand, or with slight effort on a 1" open-ended wrench, the bearing adjustment is still within tolerance (Fig. 18.17). If the hex drive gear will not turn using the wrench, bearing preload is too tight and a thicker shim should be used. For example, replace a blue .005" shim with a brown .010" shim. **At no time should the hex drive show any sign of lateral movement (side to side, fore or aft).** If the hex drive does show lateral movement, use a thinner shim. For example, replace a brown .010" shim with a blue .005" shim. Either the top or the bottom plate shim can be removed and replaced to achieve the proper tolerances. At no time should the rotation member be assembled without shims between the upper and lower plates and the gear drive box. The shims also serve as gaskets; consequently, their absence will cause leaks from the outside as well as the inside of the hammer.

**NOTE: Yellow .020" shims are available, but are rarely used because thinner shims allow for more incremental adjustments.**

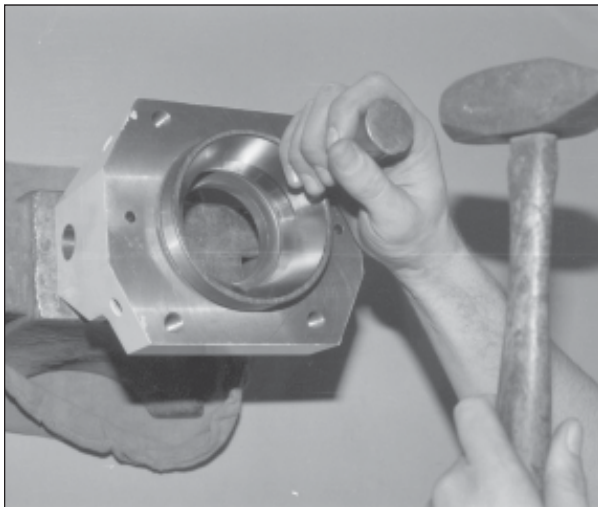
- 18.22** Once the hex drive is properly installed, insert a grease seal in the bottom plate around the lower portion of the hex drive gear (Fig. 18.18). Carefully slide the seal over the hex drive stem until it evenly contacts the bottom plate.
- 18.23** Tap the seal into place using a hammer and a seal installer (Fig. 18.19A) or a brass dowel (Fig. 18.19B).
- 18.24** Insert a grease seal in the top plate and install in the same manner as the bottom plate.
- 18.25** If the hammer alignment pins were removed during disassembly, reinstall them in the top plate with a hammer (Fig. 18.20).
- 18.26** Install drive chain (See Section 16.0, Drive Chain and 12-Tooth Sprocket Installation) disregarding Steps 16.8 through 16.10.

**CAUTION: Hammer member and rotation member are heavy. Assistance is required to handle them safely. Do not attempt to lift them by yourself.**

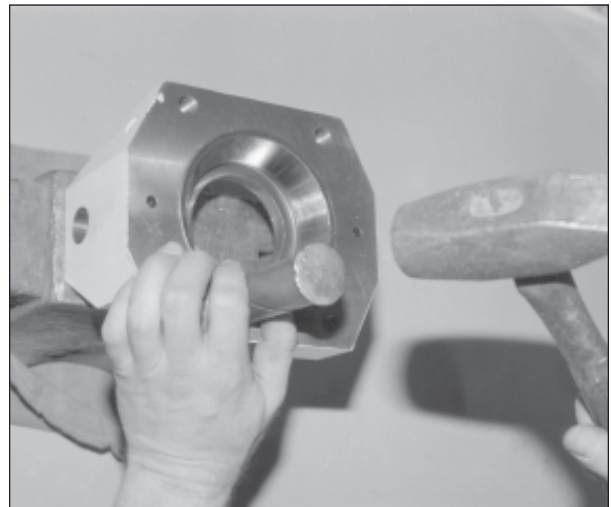
- 18.27** With assistance, place the GH-40 rotation member in the hammer cradle (Fig. 18.21) and reattach it with the four mounting bolts, lock washers, and flat washers originally used (Figs. 18.22A,B).
- 18.28** Place a new 12-tooth sprocket in the gear drive below the hydraulic motor shaft slot (Fig. 18.23).



- 18.29** Install hydraulic motor (See Section 14.0, Hydraulic Motor Installation) disregarding Steps 14.13 and 14.14 (Fig. 18.24). **Remember, all hydraulic connections remain intact during this procedure.**
- 18.30** Install hammer member (See Section 7.0, Hammer Member Installation) (Fig. 18.25).
- 18.31** Reattach marked hammer inlet and return hoses to their respective positions (Fig. 18.26).
- 18.32** The hammer member, the rotation member, and the hydraulic motor should all be reattached to the hammer cradle (Fig. 18.27).
- 18.33** Check all bolts and fittings for tightness.
- 18.34** Installation of gear drive, bearings, and seals is complete.



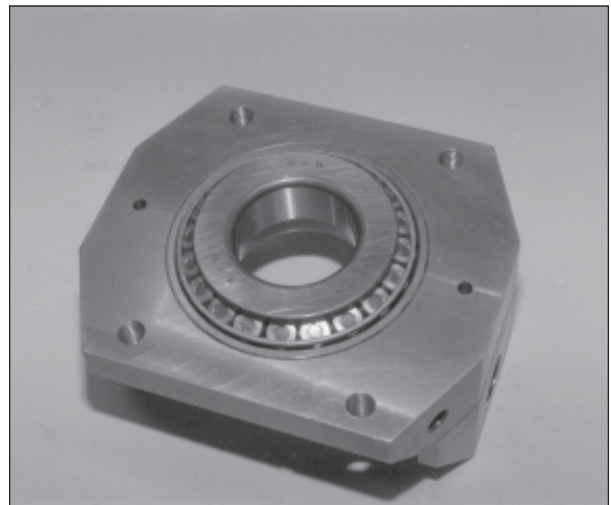
**Fig. 18.1.** Install bearing race into bottom plate.



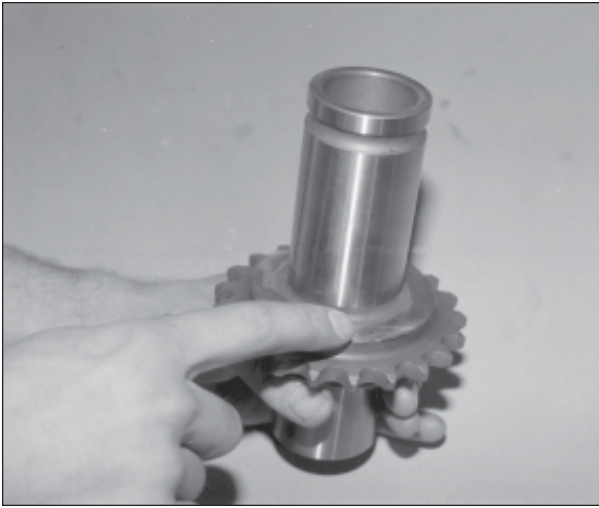
**Fig. 18.2.** Fully seat race against shoulder in bottom plate.



**Fig. 18.3.** Pack tapered roller bearings with wheel bearing grease.



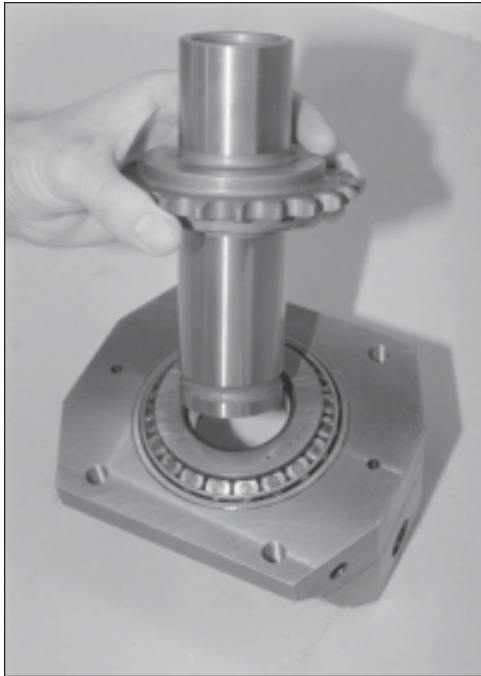
**Fig. 18.4.** Lay bearing in race in bottom plate.



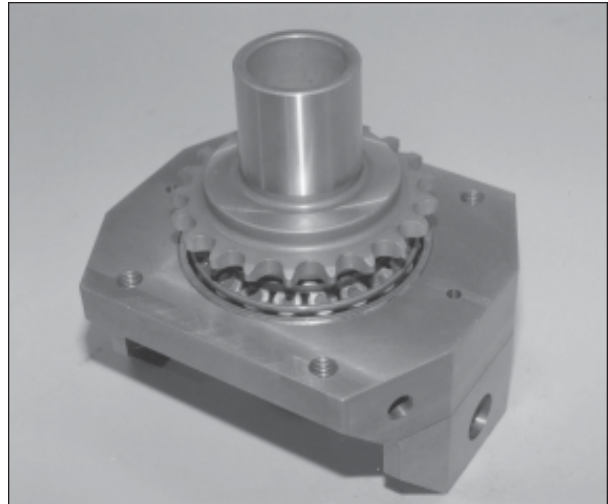
**Fig. 18.5A.** Make sure hex drive gear is free of grease.



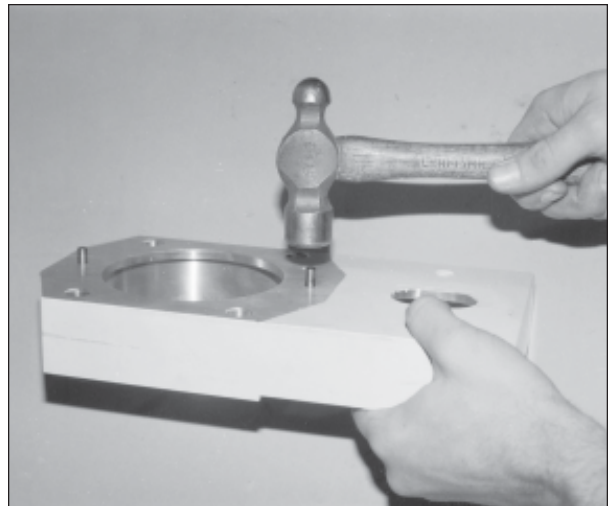
**Fig. 18.5B.** Make sure inner race surfaces are free of grease.



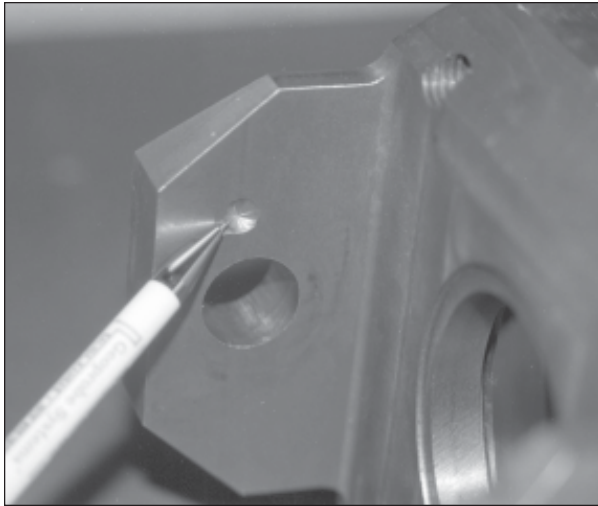
**Fig. 18.6A.** Sliding long stem of hex drive gear through bottom bearing.



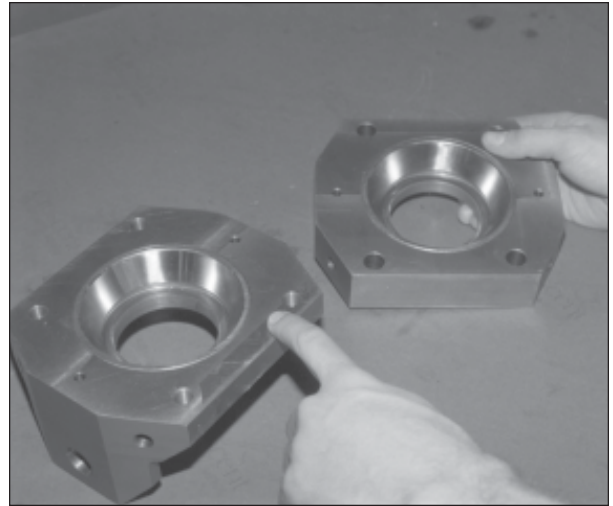
**Fig. 18.6B.** Hex drive gear seated through bottom bearing.



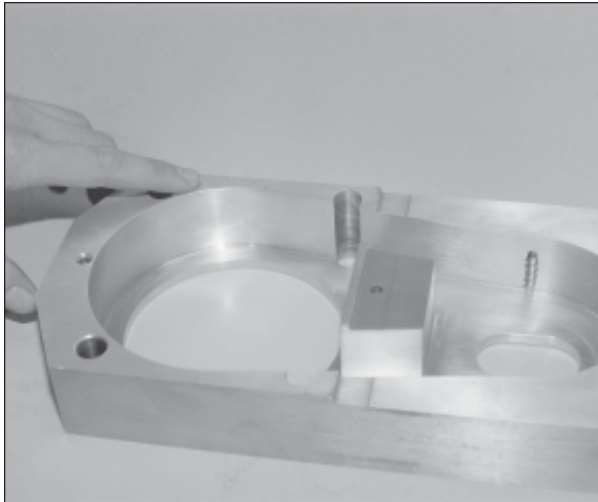
**Fig. 18.7.** Reinstall gear box alignment pins if necessary.



**Fig. 18.8. Position bottom plate so detent ball indentation is on left side of plate.**



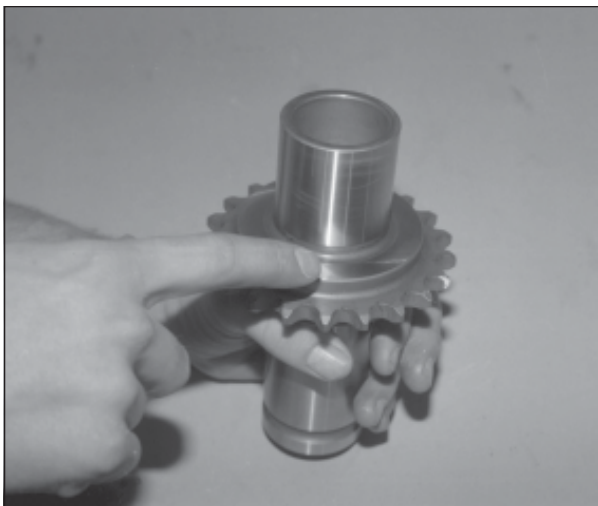
**Fig. 18.9A. Mating surface of bottom plate should be free of grease.**



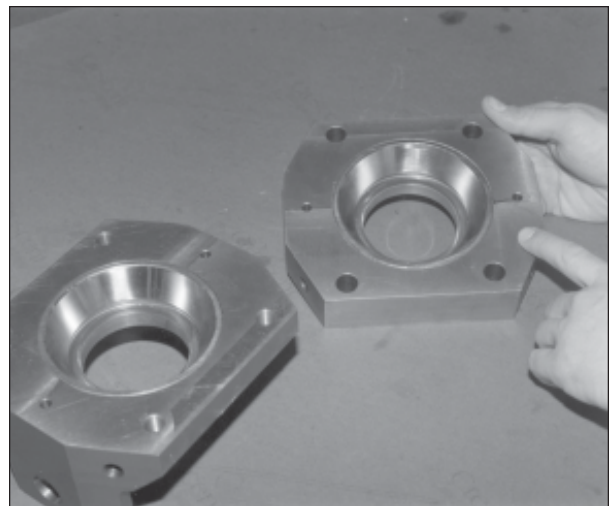
**Fig. 18.9B. Mating surface of drive gear box should be free of grease.**



**Fig. 18.10A. Inner bearing race mating surface should be free of grease.**

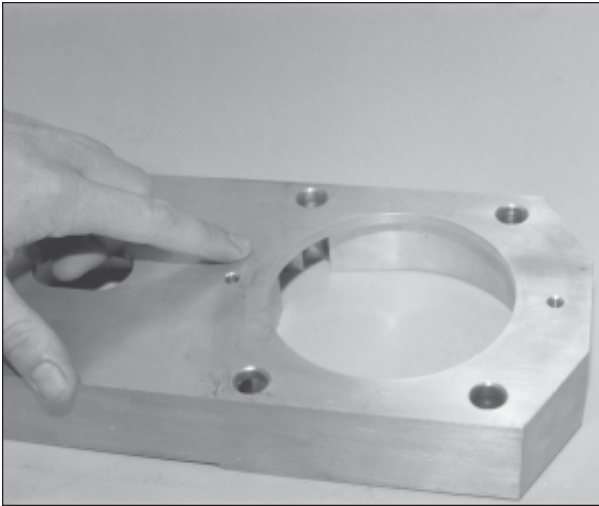


**Fig. 18.10B. Hex drive mating surface should be free of grease.**

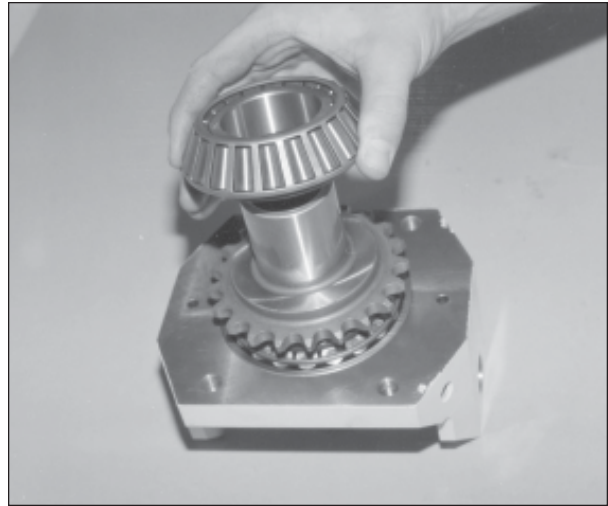


**Fig. 18.10C. Top plate mating surface should be free of grease.**

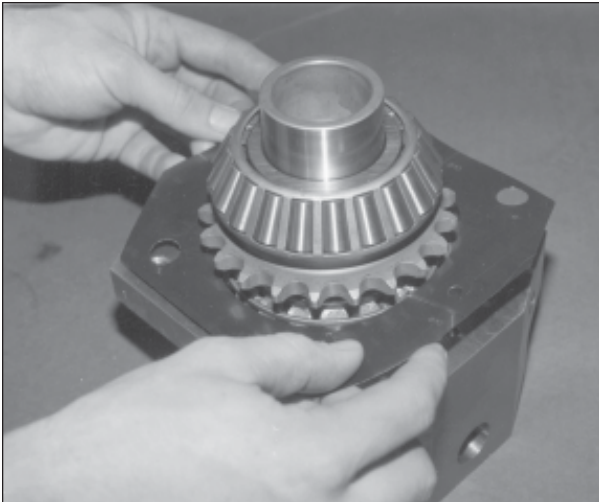




**Fig. 18.10D.** Gear drive box mating surface should be free of grease.



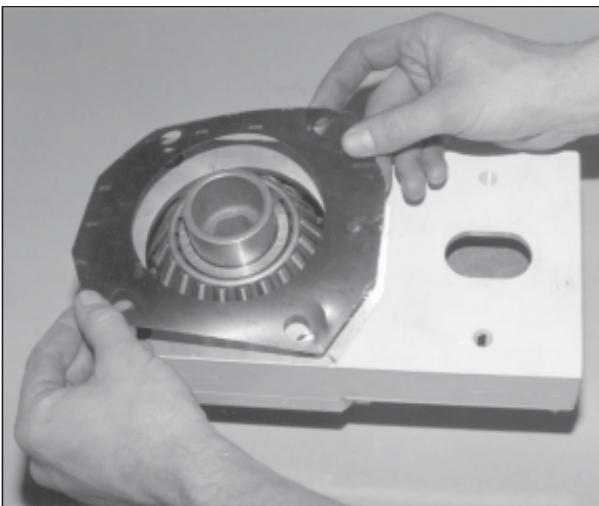
**Fig. 18.11.** Install second tapered roller bearing on hex drive gear.



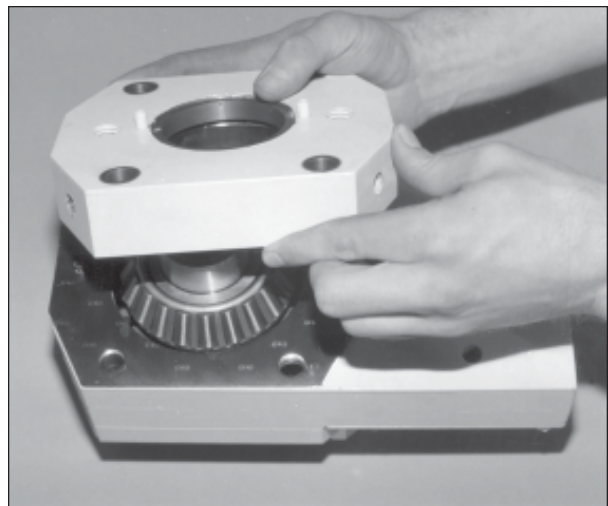
**Fig. 18.12.** Place gear box shim on bottom plate and align bolt holes.



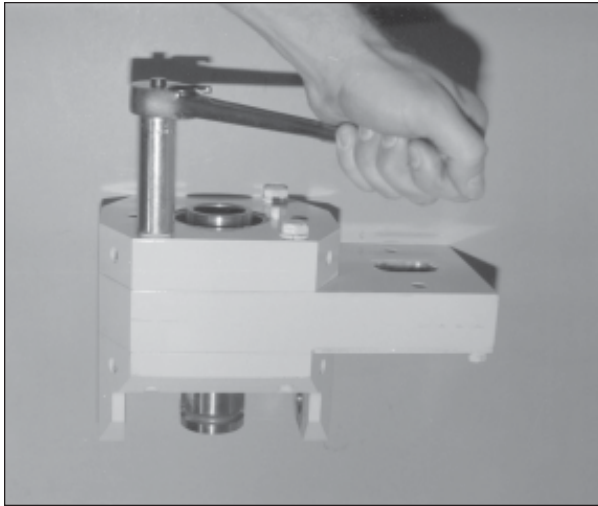
**Fig. 18.13.** Place gear drive box on bottom plate and shim making sure shim does not wrinkle.



**Fig. 18.14.** Place gear box shim on top of gear drive box.



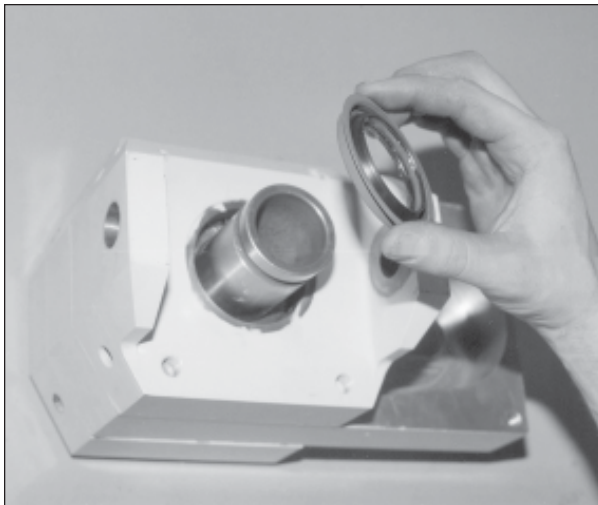
**Fig. 18.15.** Align bolt holes and install top plate on gear drive box.



**Fig. 18.16. Attach bottom plate, gear drive box, and top plate.**



**Fig. 18.17. Install drill steel, if necessary, to check hex drive gear for proper rotation.**

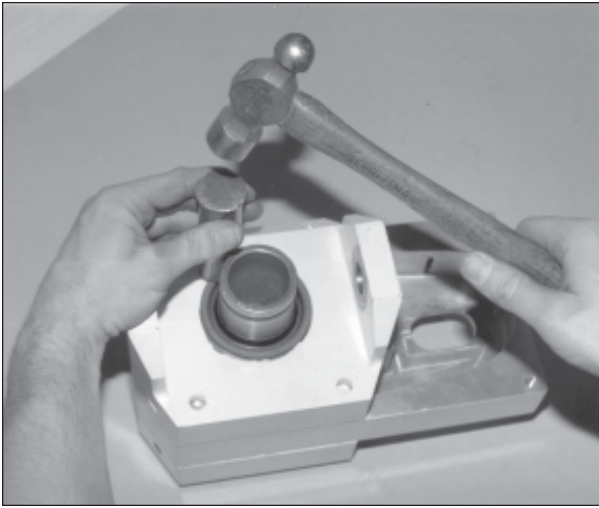


**Fig. 18.18. Install grease seal in bottom plate around lower portion of hex drive gear.**

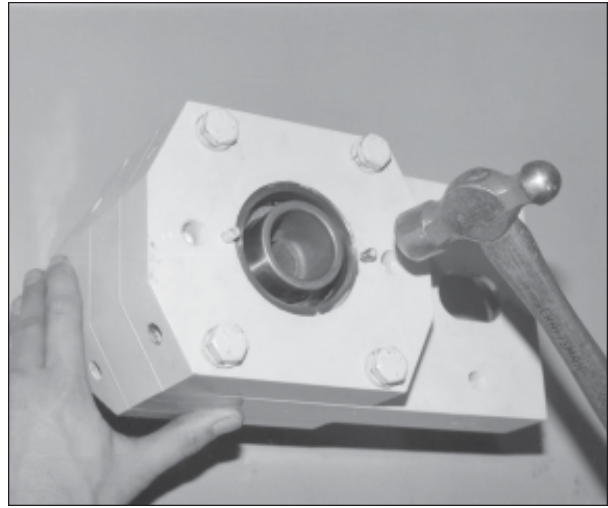


**Fig. 18.19A. Seal is tapped into place using a seal installer. (Option 1)**





**Fig. 18.19B. Seal is tapped into place using a brass dowel. (Option 2)**



**Fig. 18.20. Reinstall hammer alignment pins in top plate, if necessary.**



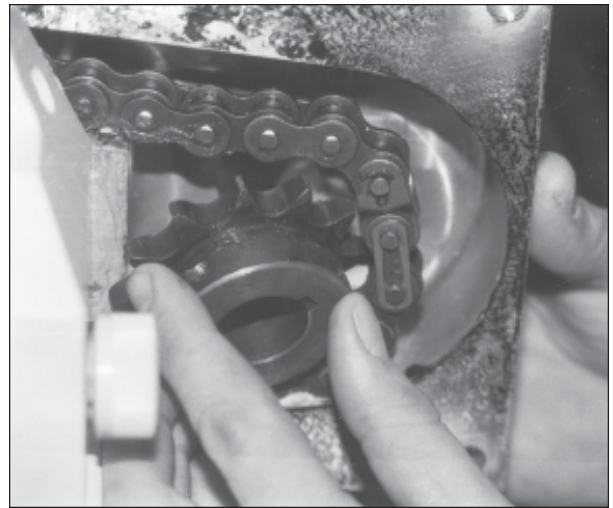
**Fig. 18.21. Reinstall GH-40 rotation member in hammer cradle.**



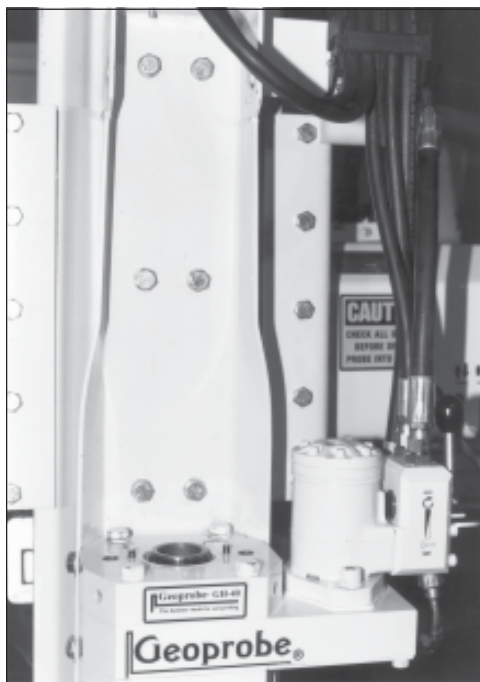
**Fig. 18.22A. Reinstall lower mounting bolts.**



**Fig. 18.22B. Reinstall lower mounting bolts.**



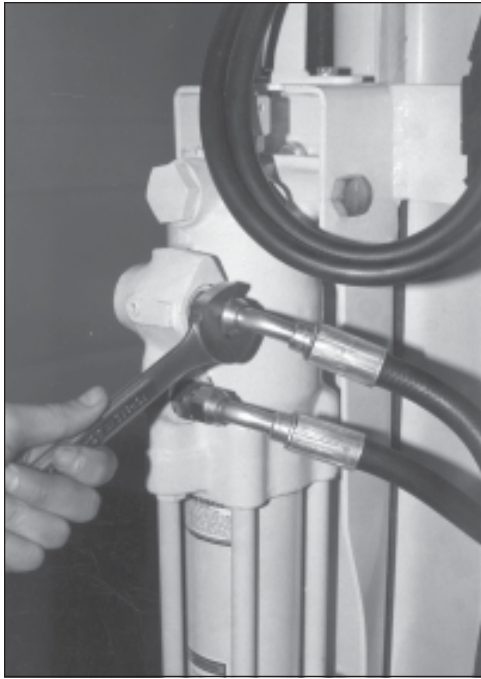
**Fig. 18.23. Place new 12-tooth sprocket in gear drive.**



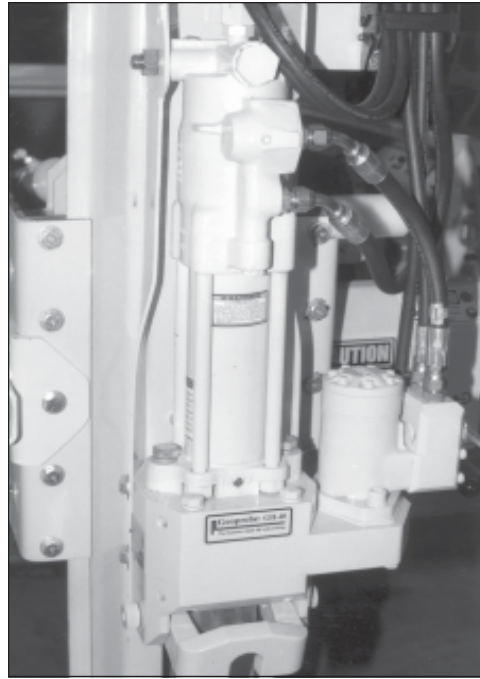
**Fig. 18.24. Reinstall hydraulic motor.**



**Fig. 18.25. Reinstall hammer member.**



**Fig. 18.26. Reattach hammer inlet and return hoses.**



**Fig. 18.27. Hammer member, rotation member, and hydraulic motor reattached to hammer cradle.**

## 19.0 HAMMER LATCH REMOVAL

**NOTE:** The following procedure for hammer latch removal occurs with the hammer member and rotary member removed from the probe unit.

**IMPORTANT:** Wear safety glasses while removing hammer latch.

**NOTE:** The hammer latch is equipped with a spring and detent ball assembly which serves as a latch stop in the rotated position. The spring and detent ball are located inside the hammer latch and apply pressure to and engage the indenture in the hammer latch extension on the bottom plate of the rotation member. When the hammer is installed on the probe unit, the detent ball and its indenture are located on the left side of the unit (opposite side of the hammer) from the control panel.

**19.1** Place hammer rotation member on work bench.

**19.2** Loosen both socket head shoulder bolts with a 7/16" hex bit and socket wrench (Fig. 19.1). The socket head shoulder bolts are installed at the factory with Loctite Removable Threadlocker and will require significant effort to remove.

**19.3** Remove both socket head shoulder bolts (Fig. 19.2).

**CAUTION:** The detent ball and spring installed in the hammer latch as a latch stop are under high spring compression. Latch removal without precaution may result in injury if the detent ball becomes airborne. Place a shop towel over detent ball location before removing shoulder bolts. Always wear safety glasses while removing detent ball and spring.

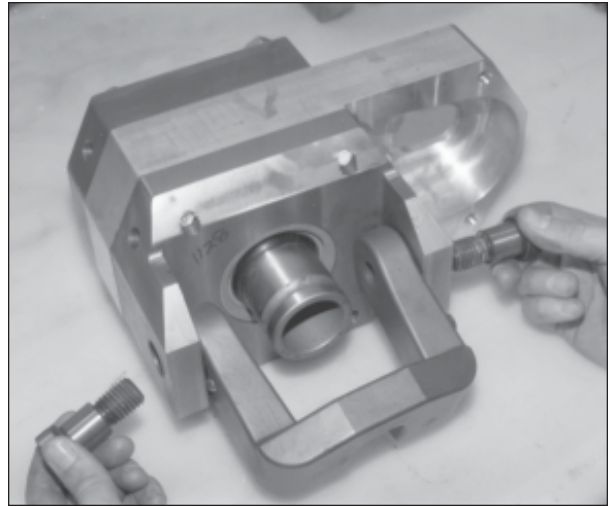
**19.4** Place a towel around the entire left side of the hammer latch (detent ball location) and pull latch away from the bottom plate (Fig. 19.3).

**19.5** Locate detent ball and spring and place in a container to prevent loss (Fig. 19.4).

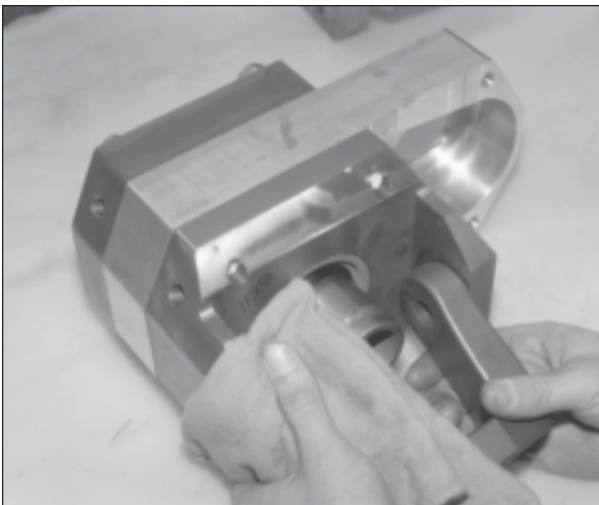
**19.6** Hammer latch removal is complete (Fig. 19.5).



**Fig. 19.1. Loosen shoulder bolts and latch assembly from bottom plate.**



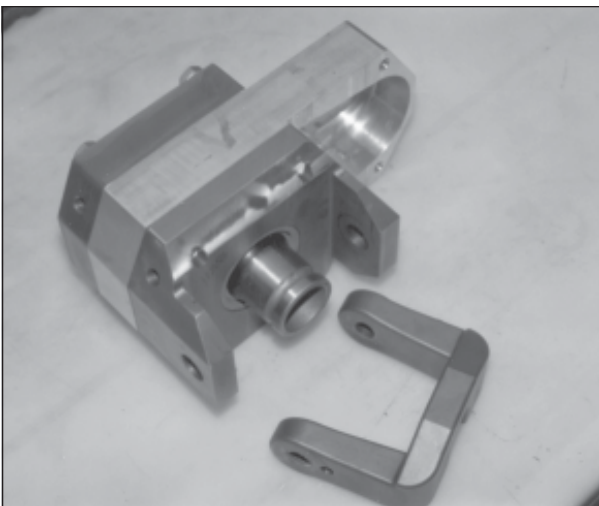
**Fig. 19.2. Remove both socket head shoulder bolts.**



**Fig. 19.3. Pull hammer latch away from bottom plate.**



**Fig. 19.4. Locate detent ball and spring and set aside.**



**Fig. 19.5. Hammer latch removal is complete.**

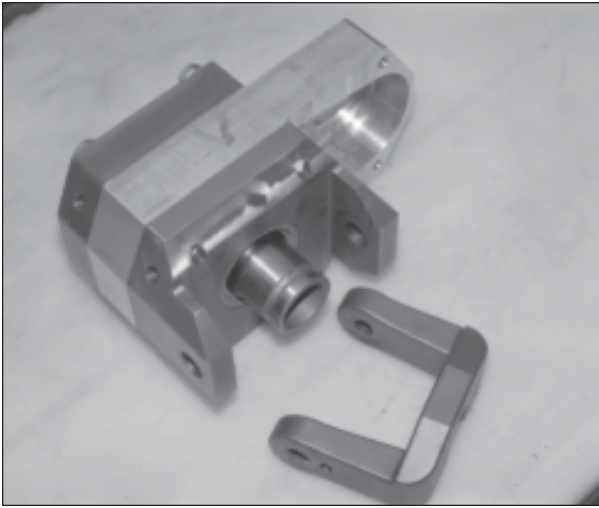


## 20.0 HAMMER LATCH INSTALLATION

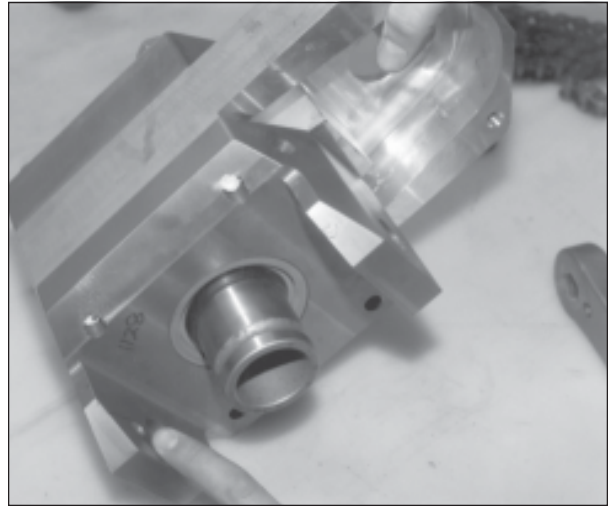
**NOTE:** The following instructions for the hammer latch installation occur with the hammer member and rotary member removed from the probe unit.

**IMPORTANT:** Always wear safety glasses while removing hammer latch.

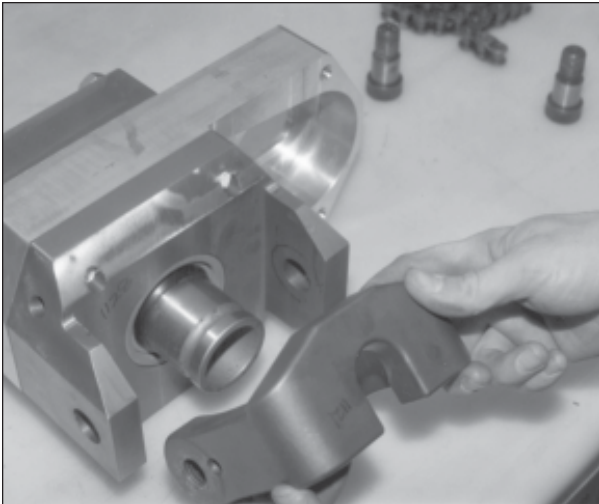
- 20.1 Place hammer latch and hammer rotation member on work bench (Fig. 20.1).
- 20.2 Situate the bottom plate or rotation member so that the detent ball indenture is on the left side of the plate (Fig. 20.2). The indenture should also be on the side of the plate nearest to the technician.
- 20.3 Position the hammer latch between the bottom plate latch extensions so that the spring hole in the latch corresponds with the indenture in the bottom plate latch extension (Fig. 20.3). The probe rod groove in the latch should face the work bench.
- 20.4 Apply a small amount of Loctite Removable Threadlocker to hammer latch shoulder bolt threads (Fig. 20.4).
- 20.5 Install shoulder bolt on the side of the latch opposite the detent ball indenture (Fig. 20.5).
- 20.6 Screw the bolt in just enough to hold the latch (Fig. 20.6). The shoulder portion of the bolt should extend only a short distance, if at all, inside the latch extension.
- 20.7 Pull the left side of the latch away from the bottom plate extension (Fig. 20.7).
- 20.8 Insert the spring into the latch in hole provided (Fig. 20.8).
- 20.9 Place detent ball against the spring and squeeze it into the latch with a pair of channel lock pliers (Fig. 20.9).
- 20.10 Push the latch towards the bottom plate while continuing to hold detent ball inside of latch (Fig. 20.10). As the latch is pushed forward, the detent ball will slide under the bottom plate latch extension.
- 20.11 Insert the left-side shoulder bolt just far enough to help align the hammer latch indenture with the latch extension (Fig. 20.11).
- 20.12 Once the detent ball is under the bottom plate latch extension, pivot the latch upwards and listen for the detent ball to click into place.
- 20.13 Remove the left-side shoulder bolt and place a small amount of Loctite Removable Threadlocker on the threads (Fig. 20.12).
- 20.14 Install the shoulder bolt through the latch extension into the hammer latch (Fig. 20.13).
- 20.15 Tighten both socket head shoulder bolts securely with a 7/16" hex bit and socket wrench (Fig. 20.14).
- 20.16 Hammer latch installation is complete.



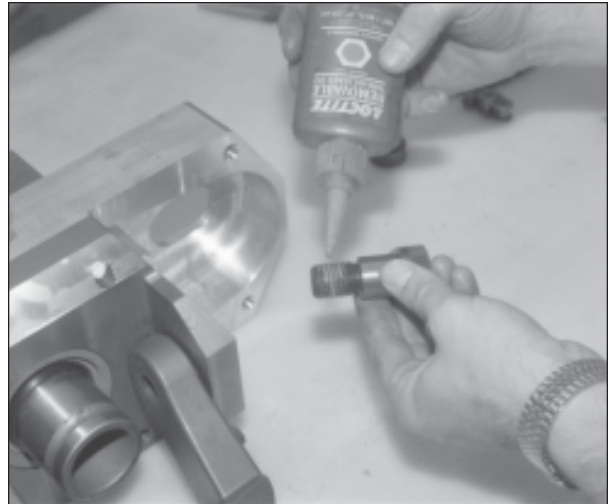
**Fig. 20.1. Place hammer latch and hammer rotation member on work bench.**



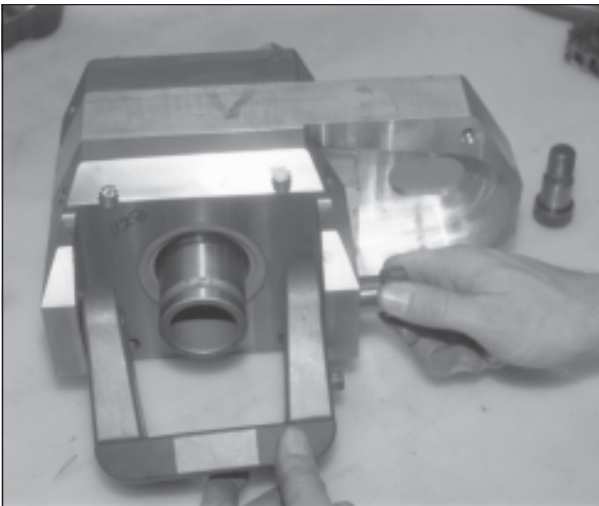
**Fig. 20.2. Situate bottom plate so detent ball indenture is located on left side of bottom plate.**



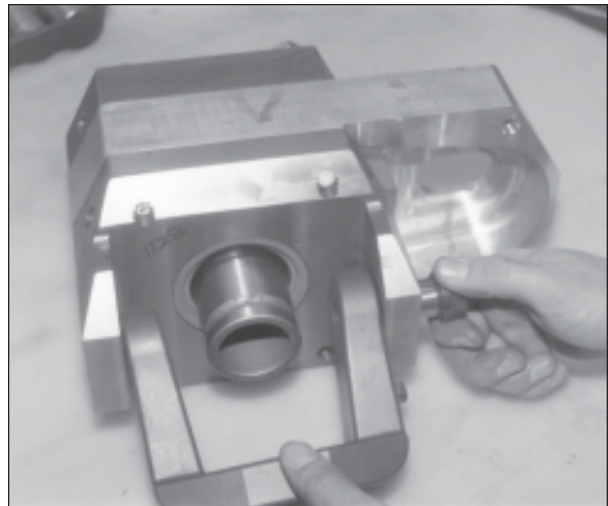
**Fig. 20.3. Position spring hole in latch to align with indenture in bottom plate latch extension.**



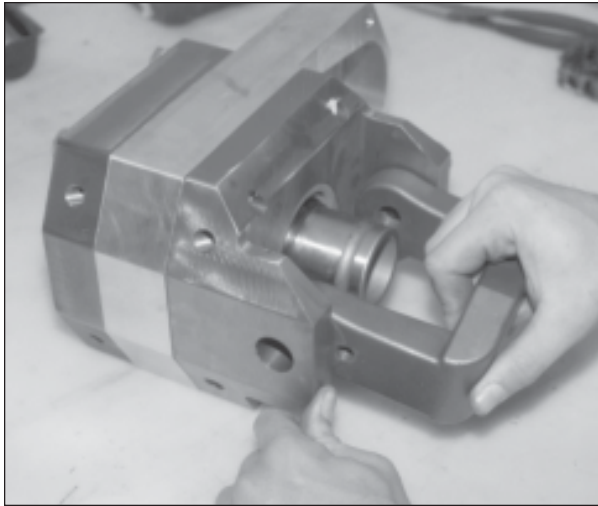
**Fig. 20.4. Apply Loctite Removable Threadlocker to hammer latch shoulder bolt.**



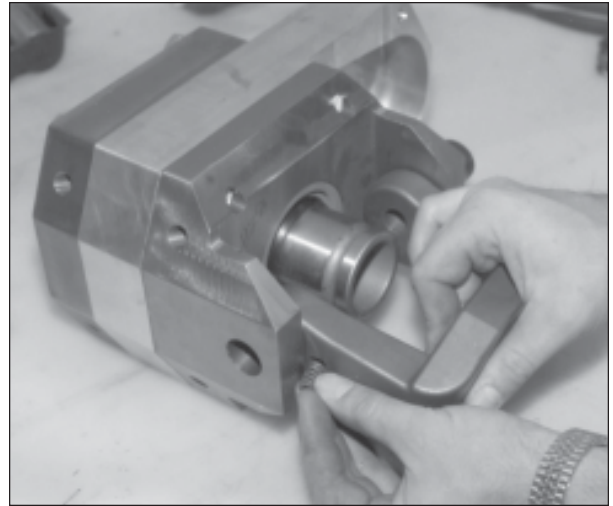
**Fig. 20.5. Install shoulder bolt in bottom plate.**



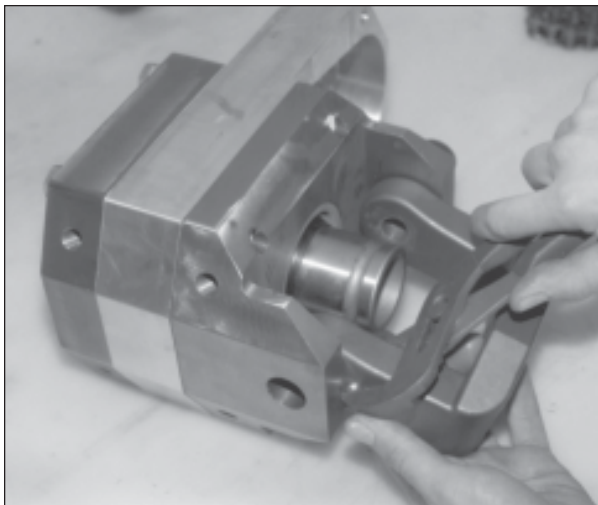
**Fig. 20.6. Screw bolt in just enough to hold the latch.**



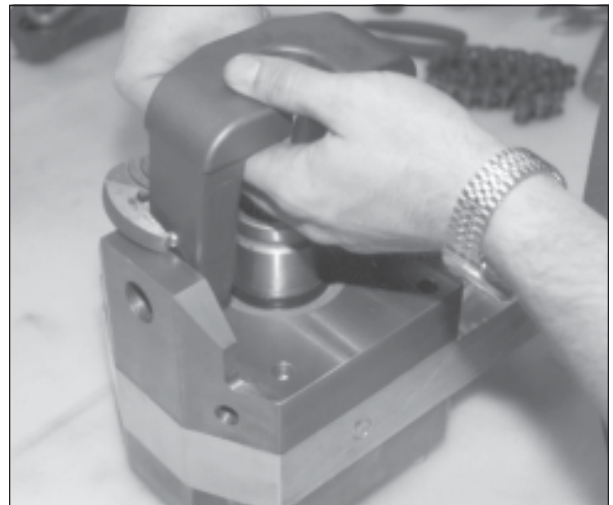
**Fig. 20.7. Pull left side of latch away from bottom plate extension.**



**Fig. 20.8. Insert spring into latch.**



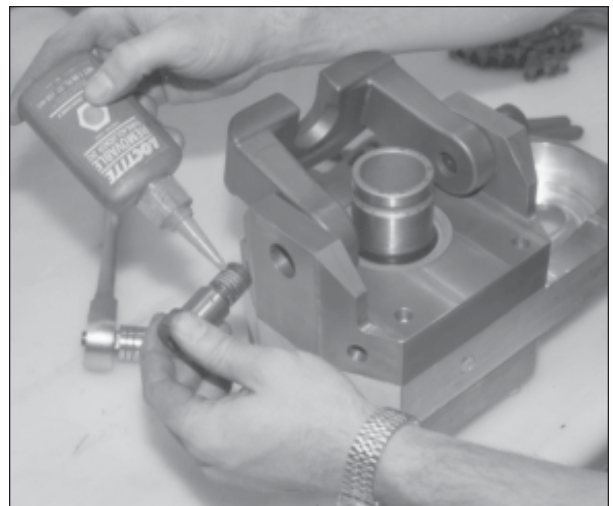
**Fig. 20.9. Place detent ball against spring and squeeze into latch.**



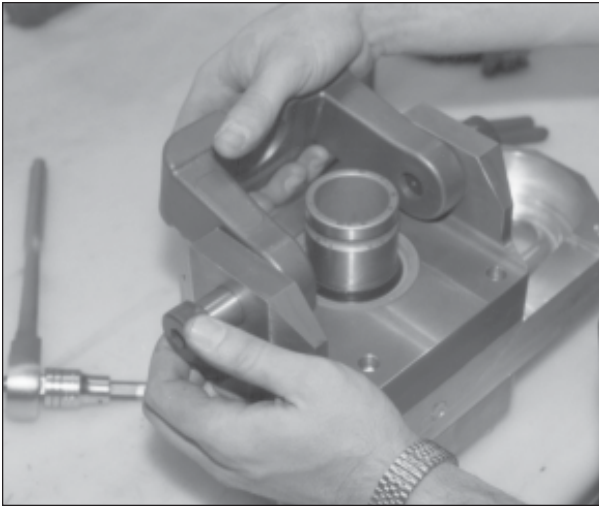
**Fig. 20.10. Push latch towards bottom plate while holding detent ball inside of latch.**



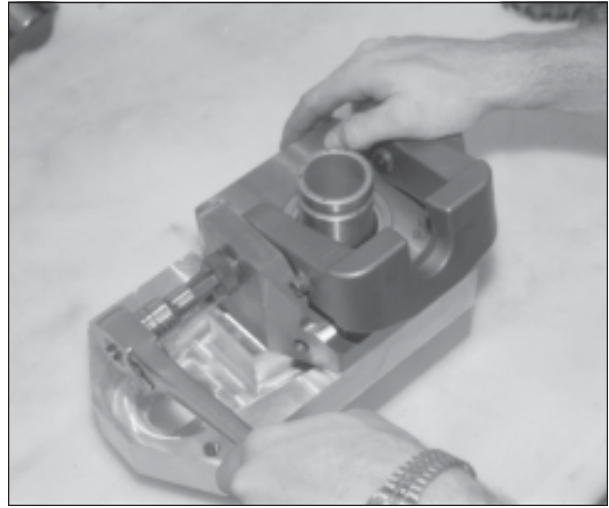
**Fig. 20.11. Insert left-side shoulder bolt just far enough to align hammer latch indenture with latch extension.**



**Fig. 20.12. Apply Loctite Removable Threadlocker on shoulder bolt threads.**



**Fig. 20.13. Install shoulder bolt through the latch extension into the hammer latch.**



**Fig. 20.14. Tighten both socket head shoulder bolts.**

## 21.0 HAMMER LATCH REMOVAL

Hammer latch failure during probing operations may require the removal of the latch while the hammer is installed on the probing machine.

**NOTE:** The following instructions for the hammer latch removal can be completed while the hammer remains installed on the probe unit.

**IMPORTANT:** Wear safety glasses while removing hammer latch.

**NOTE:** The hammer latch is equipped with a spring and detent ball assembly which serves as a latch stop in the rotated position. The spring and detent ball are located inside the hammer latch and apply pressure to and engage the indenture in the hammer latch extension on the bottom plate of the rotation member. When the hammer is installed on the probe unit, the detent ball and its indenture are located on the left side of the unit (opposite side of the hammer) from the control panel.

21.1 Extend unit fully from vehicle.

21.2 Lift hammer to the top of its stroke with the Probe Control Lever (Fig. 21.1).

21.3 Turn off (deactivate) hydraulics system and vehicle engine.

21.4 Loosen both socket head shoulder bolts with a 7/16" hex bit and socket wrench (Fig. 21.2). The socket head shoulder bolts are installed with Loctite Removable Threadlocker and require significant effort to remove.

21.5 Remove both socket head shoulder bolts (Fig. 21.3).

**CAUTION:** The detent ball and spring installed in the hammer latch as a latch stop are under high spring compression. Latch removal without precaution may result in injury if the detent ball becomes airborne. Place a shop towel over detent ball location before removing shoulder bolts.

21.6 Place a shop towel over entire left side of hammer latch (detent ball location) and pull latch away from bottom plate (Fig. 21.4).

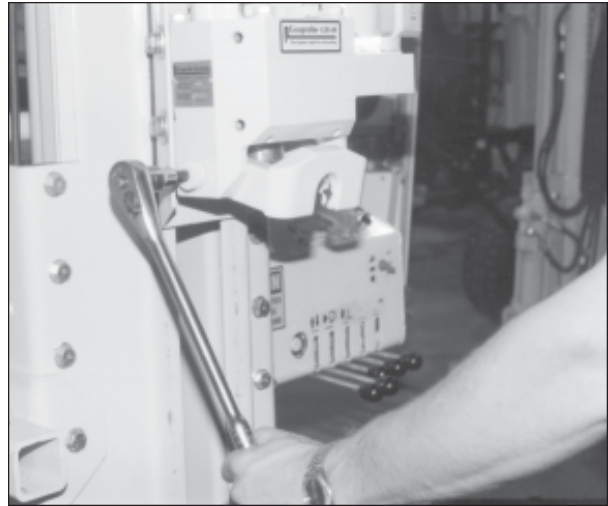
21.7 Locate detent ball and spring and place in a container to prevent loss (Fig. 21.5).

21.8 Hammer latch removal is complete.

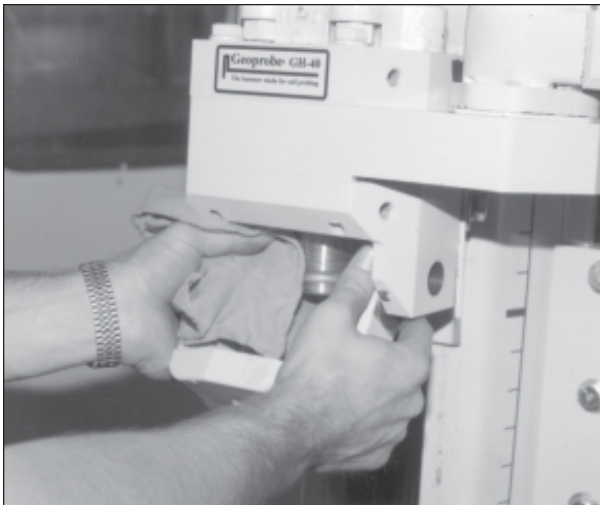




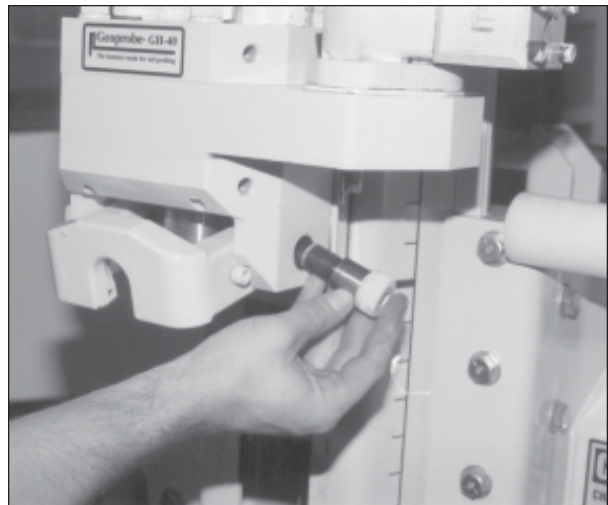
**Fig. 21.1. Lift hammer to top of stroke.**



**Fig. 21.2. Loosen both socket head shoulder bolts.**



**Fig. 21.4. Pull hammer latch away from bottom plate**



**Fig. 21.3. Remove socket head shoulder bolts.**



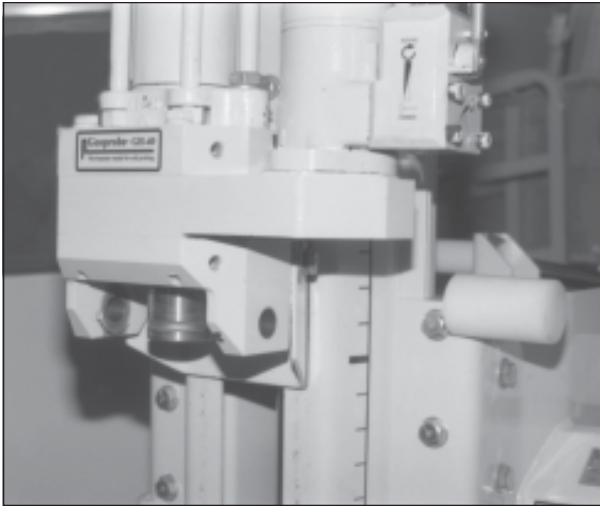
**Fig. 21.5. Locate ball bearing and spring and set aside.**

## 22.0 HAMMER LATCH INSTALLATION

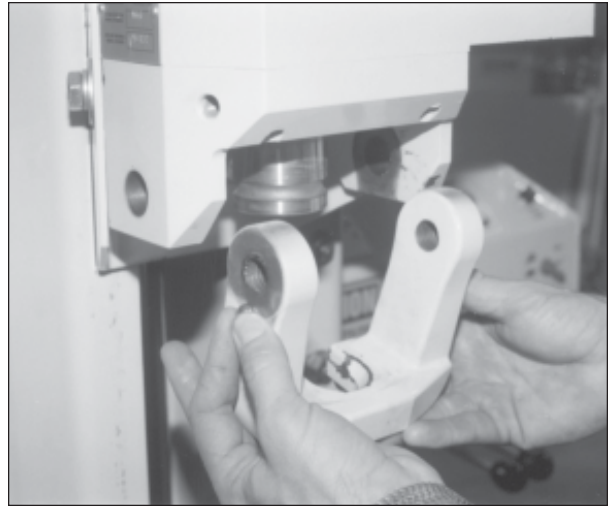
**NOTE:** The following instructions for the hammer latch installation can be completed while the hammer remains installed on the probe unit.

**IMPORTANT:** Always wear safety glasses while removing hammer latch.

- 22.1 Unit should be fully extended from the vehicle and in the same position as when the hammer latch was removed.
- 22.2 Hammer should be raised to the top of its stroke (Fig. 22.1).
- 22.3 Position the hammer latch between the bottom plate latch extensions so that the spring cavity in the latch corresponds with the indenture in the bottom plate latch extension (Fig. 22.2). The probe rod groove in the latch should face the front of the vehicle.
- 22.4 Apply a small amount of Loctite Removable Threadlocker to the threads of one hammer latch shoulder bolt (Fig. 22.3).
- 22.5 Install shoulder bolt on the side of the latch opposite the detent ball indenture (Fig. 22.4).
- 22.6 Screw the bolt in just enough to hold the latch (Fig. 22.5). The shoulder portion of the bolt should extend only a short distance, if at all, inside the latch extension.
- 22.7 Pull the left side of the latch away from the bottom plate extension (Fig. 22.6).
- 22.8 Insert the spring into the latch in hole provided (Fig. 22.7).
- 22.9 Place the detent ball against the spring and squeeze it into the latch with a pair of channel lock pliers (Fig. 22.8).
- 22.10 Pivot the latch towards the bottom plate while continuing to hold detent ball inside of latch (Fig. 22.9).
- 22.11 As the latch is pushed forward, the detent ball will slide under the bottom plate latch extension. Once the detent ball is under the bottom plate latch extension, align it with the indenture in the latch extension (Fig. 22.10).
- 22.12 Place a small amount of Loctite Removable Threadlocker on remaining shoulder bolt's threads (Fig. 22.11).
- 22.13 Install the left-side shoulder bolt through the latch extension into the hammer latch (Fig. 22.12).
- 22.14 Tighten both socket head shoulder bolts securely with a 7/16" hex bit and socket wrench (Fig. 22.13).
- 22.15 Hammer latch installation is complete (Fig. 22.14).



**Fig. 22.1. Position hammer to the top of its stroke.**



**Fig. 22.2. Bottom plate latch extensions should correspond with spring cavity in hammer latch.**



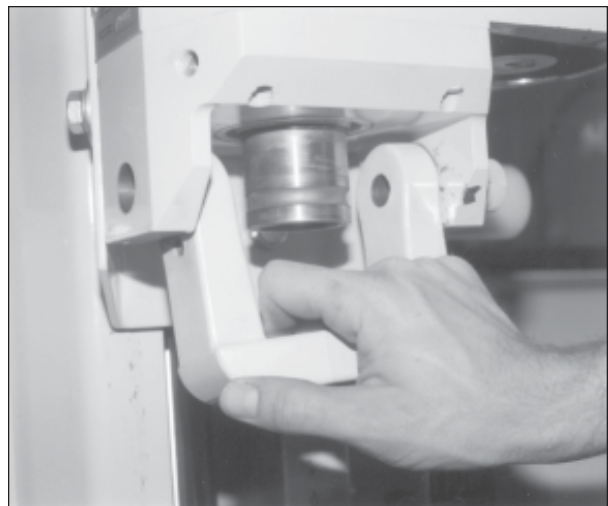
**Fig. 22.3. Apply Loctite Removable Threadlocker to hammer latch shoulder bolt.**



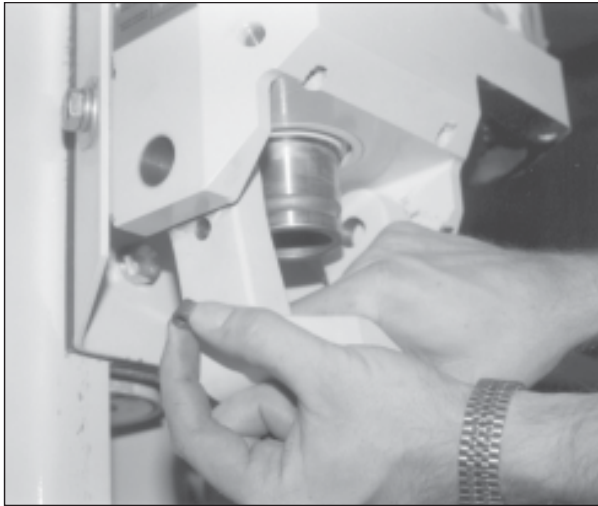
**Fig. 22.4. Install shoulder bolt on the side of latch opposite detent ball indentation.**



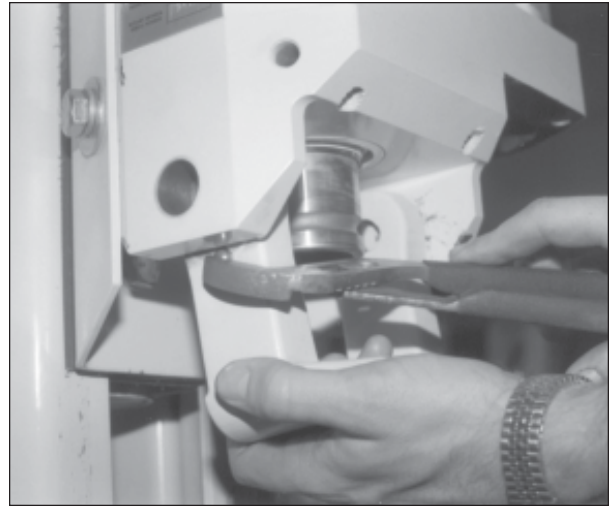
**Fig. 22.5. Screw bolt in bottom plate just enough to hold latch.**



**Fig. 22.6. Pull left side of latch away from bottom plate extension.**



**Fig. 22.7. Insert spring into latch.**



**Fig. 22.8. Place detent ball against spring and squeeze into latch.**



**Fig. 22.9. Push latch towards bottom plate while holding detent ball inside of latch.**



**Fig. 22.10. Pivot latch upward until detent ball snaps in place.**



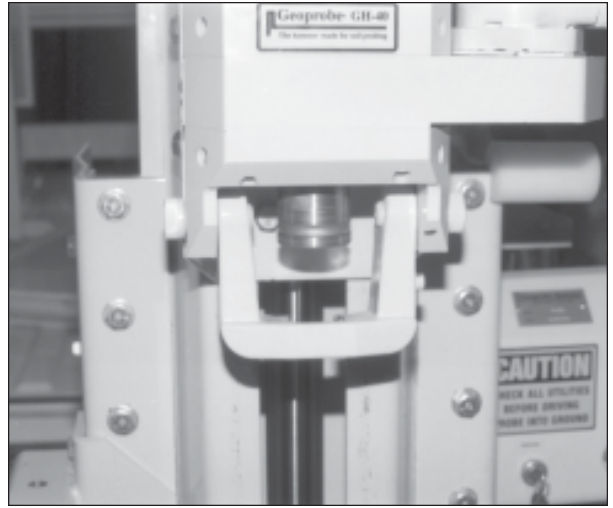
**Fig. 22.11. Apply Loctite Removable Threadlocker on shoulder bolt threads.**



**Fig. 22.12. Install shoulder bolt through the latch extension into the hammer latch.**



**Fig. 22.13. Tighten both socket head shoulder bolts.**



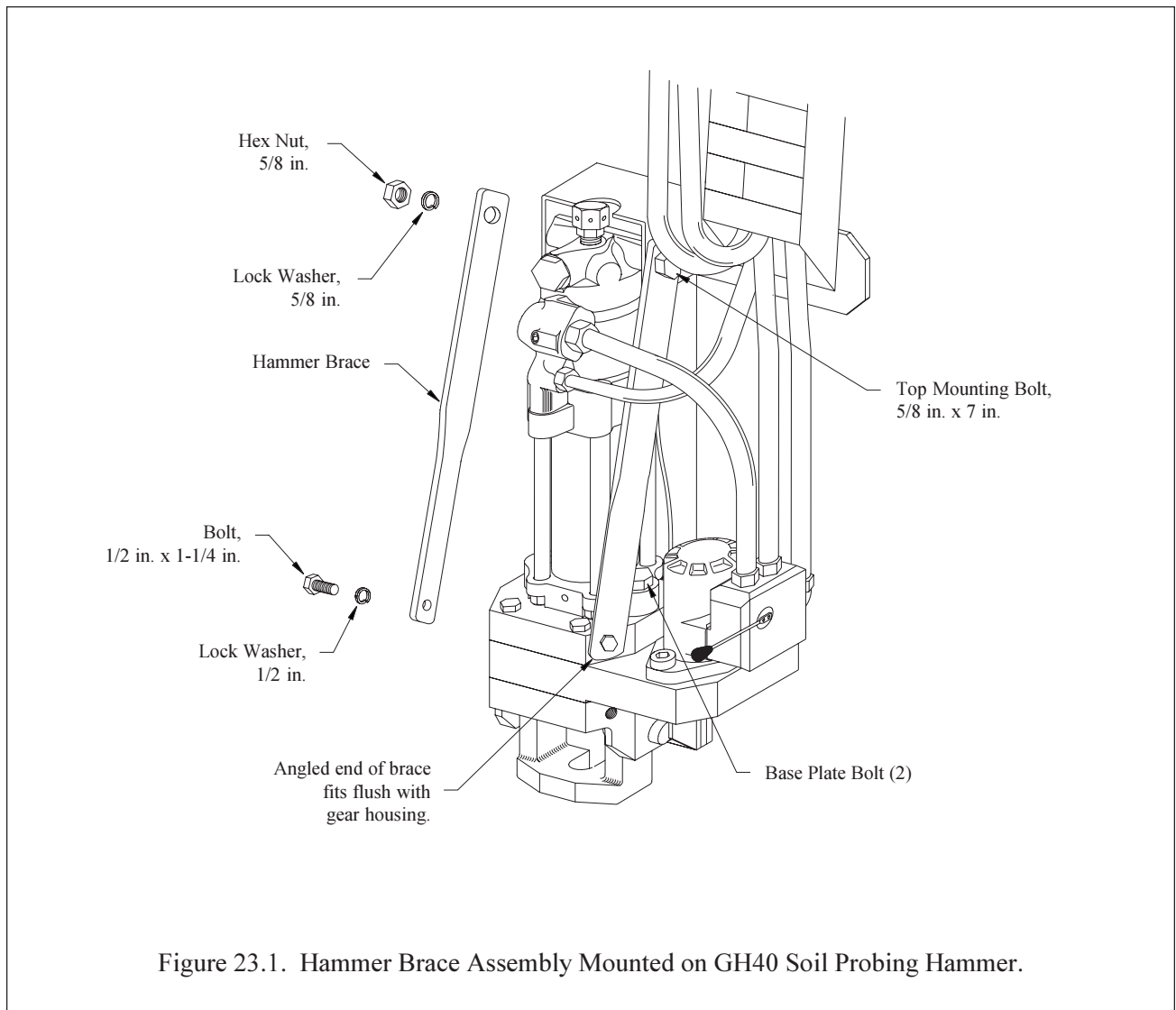
**Fig. 22.14. Hammer latch installation is complete.**



## 23.0 REMOVAL OF HAMMER BRACE ASSEMBLY

This section lists the procedure for removing a Hammer Brace Assembly (P/N 5904) from the GH-40 Soil Probing Hammer. Refer to Figure 23.1 as needed.

- 23.1 Unfold the probe assembly and position the hammer at a comfortable working height (about waist level).
- 23.2 Remove the bolt and lock washer from the lower end of each hammer brace using a 3/4" wrench or socket.
- 23.3 Remove the hex nut and lock washer from the hammer top mounting bolt with a 15/16" wrench or socket. Take off the left hammer brace.
- 23.4 Slide the top mounting bolt out of the hammer cradle and take off the remaining hammer brace. Slightly loosen the two base plate bolts to relieve pressure on the top mounting bolt if necessary.
- 23.5 Removal of the Hammer Brace Assembly is complete.



## **24.0 INSTALLATION OF HAMMER BRACE ASSEMBLY**

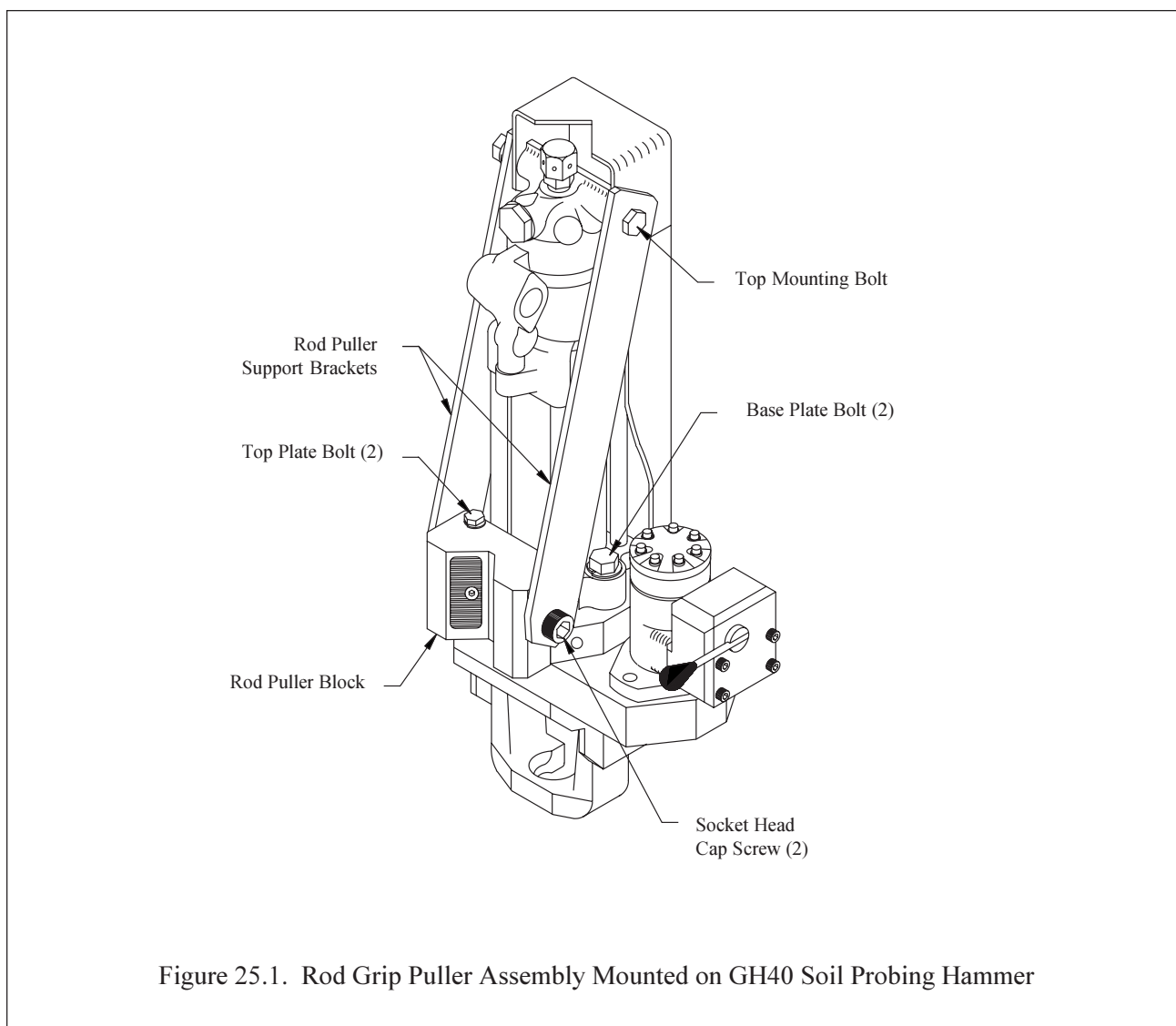
This section lists the procedure for reinstalling the Hammer Brace Assembly (P/N 5904). Refer to Figure 23.1 as needed.

- 24.1** Begin this procedure with the hammer member placed on the rotation member (within hammer cradle), the top mounting bolt removed, and the two base plate bolts and lock washers loosely installed.
- 24.2** Hold each brace in place to ensure proper bolt hole alignment. Note that a right and left brace are used. They are not interchangeable. The right brace is angled on the lower end to fit flush with the gear box.
- 24.3** Insert the 5/8" x 7" bolt through the braces and top hammer mount. Loosely attach the 5/8" lock washer and hex nut.
- 24.4** Install the two 1/2" x 1-1/4" bolts and 1/2" lock washers in the lower brace holes. Do not tighten the bolts at this time.
- 24.5** Tighten the assembly in the following sequence: Base plate bolts, lower brace bolts, and then the top mounting bolt.
- 24.6** Installation of the Hammer Brace Assembly is complete.

## 25.0 REMOVAL OF ROD GRIP PULLER ASSEMBLY

This section lists the procedure for removing a Rod Grip Puller Assembly (P/N GH-1250K, GH-2150K, or GH-3000K) from the GH-40 Soil Probing Hammer. Refer to Figure 25.1 as needed.

- 25.1 Unfold the probe assembly and position the hammer at a comfortable working height (about waist level).
- 25.2 Remove the two socket head cap screws from the rod puller block using a 3/4" or 19 mm Allen wrench or hex bit socket.
- 25.3 Remove the nut and lock washer from the top mounting bolt with a 15/16" wrench or socket and take off the left rod puller support bracket.
- 25.4 Slide the top mounting bolt out of the hammer cradle and take off the remaining rod puller support bracket. If the bolt will not slide out easily, loosen the two hammer base plate bolts and wiggle the top of the hammer to help free the bolt.
- 25.5 Remove the two top plate bolts with a 3/4" wrench or socket. Now lift off the rod puller block.
- 25.6 Removal of the Rod Grip Puller Assembly is complete.



## 26.0 INSTALLATION OF ROD GRIP PULLER ASSEMBLY

This section lists the procedure for reinstalling a Rod Grip Puller Assembly (P/N GH-1250K, GH-2150K, or GH-3000K) on the GH-40 Soil Probing Hammer. Refer to Figure 3 as needed.

- 26.1 Begin this procedure with the hammer member placed on the rotation member (within hammer cradle), the top mounting bolt removed, the two top plate bolts and lock washers removed, and the two base plate bolts and lock washers loosely installed.
- 26.2 Place the rod puller block on the front of the hammer. Loosely install two 1/2" x 7" bolts, 1/2" split lock washers, and 1/2" flat washers.
- 26.3 Install the 5/8" x 7" bolt through the support brackets and top hammer mount. Position each bracket so that the end with the angled corners will be attached to the rod puller block. The side with the longer angle should face toward the carrier vehicle. Place the 5/8" split lock washer and hex nut on the bolt, but do not tighten at this time.
- 26.4 Tighten both hammer base plate bolts.
- 26.5 Thread a 7/8" x 1-1/4" socket head cap screw through the lower end of each bracket and into the rod puller block. Move the rod puller block as needed to align the holes. Do not fully tighten the cap screws.
- 26.6 Refer to Figure 2. Securely tighten the assembly in the following sequence: Top plate bolts, top mounting bolt, and then socket head cap screws.
- 26.7 Periodically check the tightness of all fasteners for the first few hours of operation.
- 26.8 Installation of the Rod Grip Puller Assembly is complete.

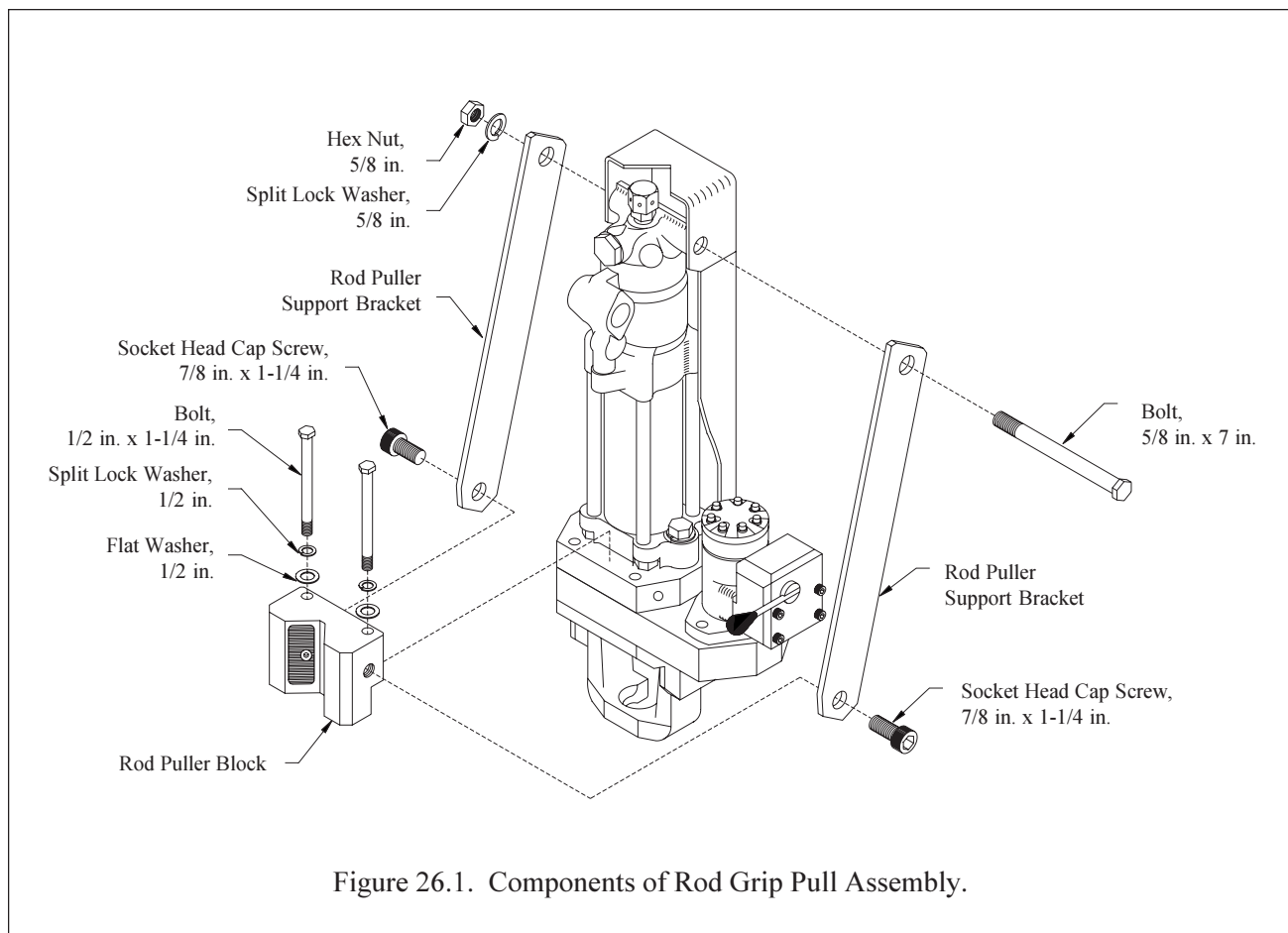


Figure 26.1. Components of Rod Grip Pull Assembly.

## 27.0 TROUBLE SHOOTING

Geoprobe Technical Service Representatives recommend that you contact the Geoprobe factory regarding any questions or problems you may have with the GH-40 Hammer. We have assembled some solutions to some typical situations that may assist you with repairs. Remember, we recommend that servicing of the GH-40 hammer be performed by a skilled technician with a thorough mechanical background. If you're still having problems after reviewing the trouble-shooting list, please call us at 1-800-436-7762.

SITUATION	PROBLEM	SOLUTION
Hammer rotation does not work.	Control lever is in wrong position.	Move control lever to "Rotate."
	Drive chain is broken.	See "Section 15.0".
	If valve spool was recently repaired, check for proper valve spool installation.	See "Section 12.0".
	Bearings are locked up.	See "Section 17.0" or send rotation member to factory.
	Hammer rotation member needs repairs.	See "Section 4.0", "Section 11.0" Steps 7 & 8, "Section 17.0" Steps 11 & 12, and send rotation member and valve and hydraulic motor to factory.
Hammer has no percussion.	Control lever is in wrong position.	Move control lever to "Hammer."
	Insufficient nitrogen charge.	See "Section 7.0".
	If hammer was recently serviced, recheck hydraulic hoses for correct connections.	See "Section 8.0".
	Hammer piston is seized.	See "Section 4.0" and send hammer member to factory.
Oil leaking from vents at the front or rear of the base plate.	Base plate seals are leaking.	See "Section 5.0".
Oil leaking excessively from hammer anvil area.	Base plate seals are leaking.	See "Section 5.0".
Oil leaking down side of hammer rotation valve.	O-rings are leaking.	See "Section 10.0" to replace O-rings.
Oil leaking from hydraulic hoses.	Fittings may be loose or damaged.	Tighten fittings or replace damaged fittings.
Oil accumulates on drill steel, on new rotation member, or around hammer anvil.	Excessive grease was used on bearings, unit is new, or bearings and seals have just been replaced.	Allow grease to work itself out.
Oil leaking from top vent on upper hammer member.	Upper seal is leaking.	See "Section 4.0" and send hammer to factory.
Low pitched noise is coming from near control panel.	Lunch time and operator's stomach is growling.	Close manual, deactivate hydraulics, eat lunch.
Hex drive has lateral or vertical movement.	Bearings need to be replaced or adjusted.	See "Section 17.0" and "Section 18.0" to replace or adjust bearings.
Hex drive has movement in the rotational plane.	Drive chain is slack.	See "Section 15.0" to tighten chain.



## ADDITIONAL TROUBLE SHOOTING TIPS

SITUATION	PROBLEM	SOLUTION
Hammer anvil stuck in anvil recepticle.	Debris has accumulated around anvil.	See "Section 4.0" and use a large punch and hammer to drive anvil out of rotation member.
Hammer is "hammering" but doesn't drive anything.	Hammer anvil is missing.	Install hammer anvil.
Hammer working intermittently, slowly, or not at all.	Lack of nitrogen in system.	See "Section 7.0" or see "Section 4.0" and send to factory.
Hammer gets too hot when hammering.	Hydraulic fluid cooler may be dirty.	Use compressed air or a pressure washer to remove any debris from cooler fins.
Hammer gets too hot when hammering.	Vehicle cooling fan may not be operating properly.	Check vehicle cooling fan for proper operation.
Hammer latch will not swivel up or down.	Hammer latch may need lubrication.	Lubricate shoulder bolts and steel detent ball with silicone or graphite lubricant. If lubrication fails, See "Section 19.0" for removal.
Hammer anvil retainer cap will not go on or come off.	Hammer anvil retainer cap may need lubrication.  Detent ball groove in hex drive has been deformed from excessive pulling.	Lubricate steel retainer balls in anvil retainer cap with silicone or graphite lubricant (WD-40 may be necessary).  See "Section 17.0" to replace hex drive.

If you do not wish to make any repairs to the GH-40 hammer yourself, please call a service representative and request a Return Authorization Number to send your GH-40 hammer or any component to the factory. This will expedite your return and assist with service. Geoprobe personnel are here to help whenever possible with whatever problem you may have. Our telephone number is 1-800-GEOPROBE (1-800-436-7762).

## **24.0 REFERENCES**

Geoprobe Systems, August 1993, "1993-94 Equipment and Tools Catalog."

Geoprobe Systems, October 1994, "Geoprobe GH-40 Soil Probing Hammer, Operating Instructions."

Geoprobe Systems, October 1997, "1998-99 Equipment and Tools Catalog."



**Corporate Headquarters**

601 N. Broadway • Salina, Kansas 67401

1-800-GEOPROBE (1-800-436-7762) • (785) 825-1842 • Fax (785) 825-2097

**Hydraulic Probing Machines • Small Diameter Sampling Tools • Direct Sensing and Logging Tools**